

**Koło łańcuchowe z piastą 5 x 2.5 mm (03-1)**  
dla łańcucha rolkowego DIN 8187/ ISO R606

Materiał

Stal C 43

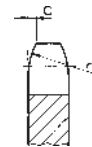
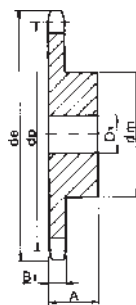
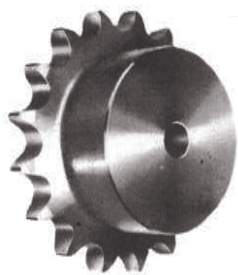

1-rzędowe Kod	Ilość zębów z	de	dp	1-rzędowe		
				A	dm	D1
Na zapytanie	8	14.8	13.06	10	7	4
	9	16.4	14.62	10	8	5
	10	17.9	16.18	10	9	5
	11	19.5	17.75	10	11	6
	12	21.1	19.32	10	12	6
	13	22.6	20.89	10	14	6
	14	24.2	22.47	10	15	6
	15	25.8	24.04	10	16	6
	16	27.4	25.63	13	18	8
	17	29.0	27.20	13	18	8
	18	30.5	28.79	13	18	8
	19	32.1	30.38	13	18	8
	20	33.7	31.96	13	18	8
	21	35.3	33.54	13	20	8
	22	36.9	35.13	13	20	8
	23	38.5	36.72	13	20	8
	24	40.1	38.30	13	20	8
	25	41.6	39.89	13	20	8
	26	43.2	41.48	15	25	8
	27	44.8	43.07	15	25	8
	28	46.4	44.65	15	25	8
	29	48.0	46.25	15	25	8
	30	49.6	47.83	15	25	8
	31	51.2	49.42	15	30	8
	32	52.8	51.01	15	30	8
	33	54.4	52.60	15	30	8
	34	55.9	54.19	15	30	8
	35	57.5	55.78	15	30	8
	36	59.1	57.37	15	30	8
	37	60.7	58.96	15	30	8
	38	62.3	60.54	15	30	8
	39	63.9	62.13	15	30	8
	40	65.5	63.73	15	30	8

B1	r3	c
2.3	5	0.4

Rozmiary w mm.

# Koło łańcuchowe z piastą 6 x 2.8 mm (04-1)

dla łańcucha rolkowego DIN 8187/ ISO R606

Materiał

Stal C 43

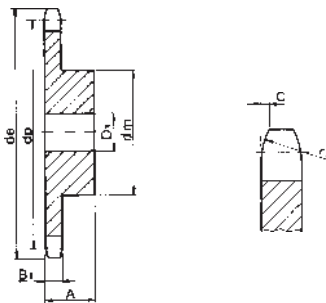
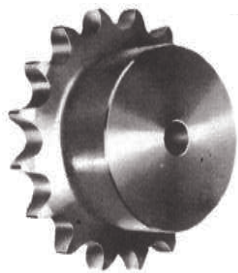

1-rzędowe Kod	Ilość zębów z	de	dp	1-rzędowe		
				A	dm	D1
T 13615	8	18.0	15.67	10	9.8	5
T 13616	9	19.9	17.54	10	11.5	5
T 13617	10	21.7	19.42	10	13.0	6
T 13618	11	23.6	21.30	10	14.0	6
T 13619	12	25.4	23.18	10	16.0	6
T 13620	13	27.3	25.05	10	18.0	6
T 13621	14	29.2	26.96	10	20.0	6
T 13622	15	31.1	28.86	10	20.0	6
T 13623	16	33.0	30.76	13	20.0	8
T 13624	17	35.0	32.65	13	20.0	8
T 13625	18	36.9	34.55	13	20.0	8
T 13626	19	38.8	36.44	13	20.0	8
T 13627	20	40.7	38.34	13	20.0	8
T 13628	21	42.6	40.25	13	25.0	8
T 13629	22	44.5	42.16	13	25.0	8
T 13630	23	46.4	44.06	13	25.0	8
T 13631	24	48.3	45.96	13	25.0	8
T 13632	25	50.2	47.87	13	25.0	8
T 13633	26	52.1	49.77	15	30.0	8
T 13634	27	54.0	51.67	15	30.0	8
T 13635	28	55.9	53.58	15	30.0	8
T 13636	29	57.8	55.50	15	30.0	8
T 13637	30	59.8	57.42	15	30.0	8
T 13638	31	61.7	59.31	15	30.0	10
T 13639	32	63.6	61.21	15	30.0	10
T 13640	33	65.5	63.11	15	30.0	10
T 13641	34	67.4	65.02	15	30.0	10
T 13642	35	69.3	66.93	15	30.0	10
T 13643	36	71.2	68.84	15	30.0	10
T 13644	37	73.1	70.75	15	30.0	10
T 13645	38	75.0	72.66	15	30.0	10
T 13646	39	76.9	74.56	15	30.0	10
T 13647	40	78.9	76.47	15	30.0	10
T 64962	45	88.5	86.01	18	62.0	12
T 64963	50	98.0	95.55	18	62.0	12
T 64964	57	111.4	108.93	18	62.0	12

B1	r3	c
2.6	6	0.6

Rozmiary w mm.

# Koło łańcuchowe z piastą 8 x 3 mm (05B -1 -2)

dla łańcucha rolkowego DIN 8187/ ISO R606

Materiał

Stal C 43

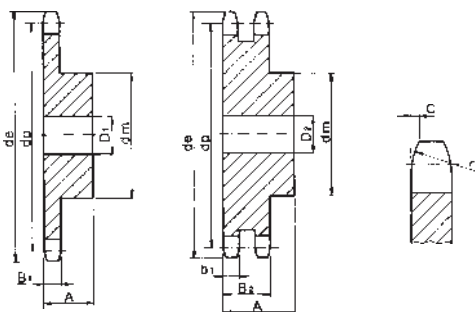
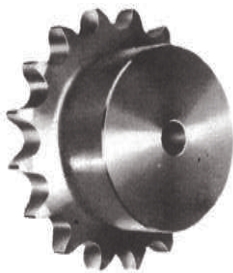

1-rzędowe Kod	2-rzędowe Kod	Ilość zębów z	de	dp	1-rzędowe			2-rzędowe		
					A	dm	D1	A	dm	D2
T 13648	T 13681	8	23.4	20.90	12	13	6	18	12	6
T 13649	T 13682	9	25.9	23.39	12	15	6	18	15	6
T 13650	T 13683	10	28.4	25.89	12	17	6	18	17	8
T 13651	T 13684	11	31.0	28.39	13	18	7	18	19	8
T 13652	T 13685	12	33.7	30.91	13	20	7	18	21	8
T 13653	T 13686	13	36.7	33.42	13	23	7	18	24	8
T 13654	T 13687	14	39.2	35.95	13	25	7	18	26	8
T 13655	T 13688	15	41.7	38.48	13	28	7	18	29	8
T 13656	T 13689	16	44.2	41.01	14	30	8	20	32	10
T 13657	T 13690	17	46.7	43.53	14	30	8	20	34	10
T 13658	T 13691	18	49.2	46.07	14	30	8	20	37	10
T 13659	T 13692	19	51.7	48.61	14	30	8	20	39	10
T 13660	T 13693	20	54.2	51.14	14	30	8	20	40	10
T 13661	T 13694	21	57.2	53.67	14	35	8	20	45	12
T 13662	T 13695	22	59.4	56.21	14	35	8	20	45	12
T 13663	T 13696	23	62.2	58.75	14	35	8	20	45	12
T 13664	T 13697	24	64.7	61.29	14	35	8	20	45	12
T 13665	T 13698	25	67.2	63.83	14	35	8	20	45	12
T 13666	T 13699	26	69.7	66.37	16	40	10	22	50	12
T 13667	T 13700	27	72.3	68.91	16	40	10	22	50	12
T 13668	-	28	74.7	71.45	16	40	10	-	-	-
T 13669	-	29	77.2	73.99	16	40	10	-	-	-
T 13670	T 13703	30	80.2	76.53	16	40	10	22	50	12
T 13671	-	31	82.7	79.08	16	40	12	-	-	-
T 13672	T 13705	32	85.2	81.61	16	40	12	22	60	12
T 13673	T 13706	33	87.7	84.16	16	40	12	22	60	12
T 13674	-	34	90.2	86.70	16	40	12	-	-	-
T 13675	T 13708	35	92.7	89.24	16	40	12	22	60	12
T 13676	T 13709	36	95.2	91.79	16	40	12	22	60	12
T 13677	-	37	97.7	94.33	16	40	12	-	-	-
T 13678	T 13711	38	100.2	96.88	16	40	12	22	60	12
T 13679	-	39	102.7	99.42	16	40	12	-	-	-
T 13680	T 13713	40	105.7	101.97	16	40	12	22	60	12
T 64965	-	45	118.6	114.69	20	60	12	-	-	-
T 64966	-	48	131.5	127.41	20	60	12	-	-	-
T 64967	-	57	149.3	145.22	20	80	14	-	-	-

B1	B2	r3	c	b1
2.8	8.3	8	0.8	2.7

Rozmiary w mm.

# Koło łańcuchowe z piastą 3/8"x7/32" (06B -1 -2 -3) dla łańcucha rolkowego DIN 8187/ ISO R606

Materiał

Stal C 43

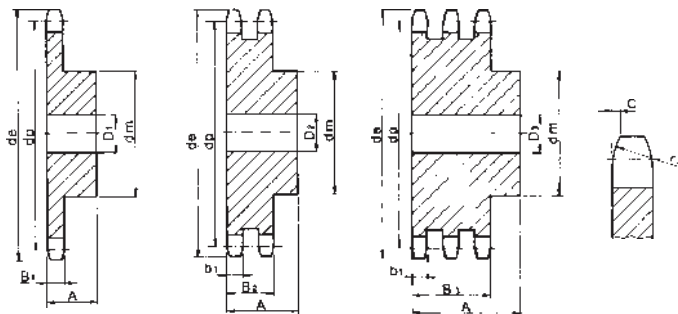
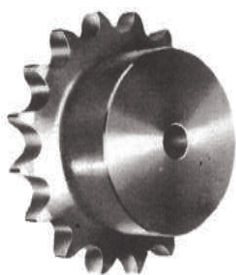

1-rzędowe	2-rzędowe	3-rzędowe	Ilość zębów z	de	dp	1-rzędowe			2-rzędowe			3-rzędowe		
Kod	Kod	Kod				A	dm	D1	A	dm	D2	A	dm	D3
T 10829	T 13714	T 13747	8	26.8	24.89	20	15	8	25	15	8	32	15	8
T 09578	T 13715	T 13748	9	31.5	27.85	20	18	8	25	18	8	32	18	8
T 10114	T 13716	T 13749	10	34.5	30.82	20	20	8	25	20	8	32	20	10
T 08188	T 13717	T 13750	11	37.5	33.80	25	22	8	30	22	10	35	22	12
T 08189	T 13718	T 13751	12	40.5	36.80	25	25	8	30	25	10	35	25	12
T 08190	T 13719	T 13752	13	43.5	39.80	25	28	10	30	28	10	35	28	12
T 08191	T 13720	T 13753	14	46.5	42.80	25	31	10	30	31	10	35	31	12
T 08192	T 13721	T 13754	15	49.5	45.81	25	34	10	30	34	10	35	34	12
T 08193	T 13722	T 13755	16	52.5	48.82	28	37	10	30	37	12	35	37	12
T 08194	T 13723	T 13756	17	55.5	51.83	28	40	10	30	40	12	35	40	12
T 08195	T 13724	T 13757	18	58.6	54.85	28	43	10	30	43	12	35	43	12
T 08196	T 13725	T 13758	19	61.6	57.87	28	45	10	30	46	12	35	46	12
T 08199	T 13726	T 13759	20	64.6	60.89	28	46	10	30	49	12	35	49	12
T 10830	T 13727	T 13760	21	67.6	63.91	28	48	12	30	52	16	40	52	16
T 10831	T 13728	T 13761	22	70.6	66.93	28	50	12	30	55	16	40	55	16
T 10832	T 13729	T 13762	23	73.7	69.95	28	52	12	30	58	16	40	58	16
T 08197	T 13730	T 13763	24	76.7	72.97	28	54	12	30	61	16	40	61	16
T 10833	T 13731	T 13764	25	79.7	76.00	28	57	12	30	64	16	40	64	16
T 10834	T 13732	T 13765	26	82.7	79.02	28	60	12	30	67	16	40	67	16
T 08198	T 13733	T 13766	27	85.7	82.04	28	60	12	30	70	16	40	70	16
T 10790	T 13734	T 13767	28	88.8	85.07	28	60	12	30	73	16	40	73	16
T 10835	T 13735	T 13768	29	91.8	88.09	28	60	12	30	76	16	40	76	16
T 10836	T 13736	T 13769	30	94.8	91.12	30	60	12	30	79	16	40	79	16
T 10837	T 13737	T 13770	31	97.9	94.15	30	65	14	30	80	16	40	80	16
T 10838	T 13738	T 13771	32	100.9	97.17	30	65	14	30	80	16	40	80	16
T 10839	T 13739	T 13772	33	103.9	100.20	30	65	14	30	80	16	40	80	16
T 10840	T 13740	T 13773	34	106.9	103.23	30	65	14	30	80	16	40	85	16
T 10841	T 13741	T 13774	35	110.0	106.26	30	65	14	30	80	16	40	85	16
T 10842	T 13742	T 13775	36	113.0	109.29	30	70	16	30	90	16	40	90	16
T 12892	T 13743	T 13776	37	116.0	112.32	30	70	16	30	90	16	40	90	16
T 10843	T 13744	T 13777	38	119.0	115.34	30	70	16	30	90	16	40	90	16
T 12893	T 13745	T 13778	39	122.1	118.37	30	70	16	30	90	16	40	90	16
T 10844	T 13746	T 13779	40	125.1	121.40	30	70	16	30	90	16	40	90	16

B1	B2	B3	r3	c	b1
5.3	15.4	25.6	10	1	5.2

Rozmiary w mm.

# Koło łańcuchowe z piastą 1/2" x 1/8" (081-1)

dla łańcucha rolkowego DIN 8187/ ISO R606

Materiał

Stal C 43

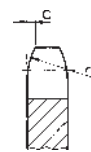
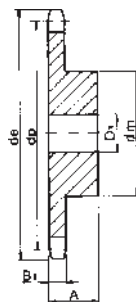
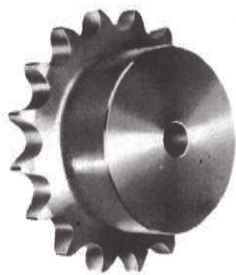

$z \leq 31$

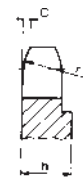

$z \geq 31$

1-rzędowe Kod	Ilość zębów z	de	dp	1-rzędowe		
				A	dm	D1
T 12894	8	39.5	33.18	14	21	8
T 12895	9	43.4	37.13	14	25	8
T 12896	10	47.4	41.10	14	28	8
T 12897	11	51.4	45.07	16	31	8
T 08200	12	55.4	49.07	16	35	8
T 08201	13	59.4	53.06	16	39	8
T 08202	14	63.4	57.07	16	43	8
T 08203	15	67.4	61.09	16	47	8
T 08204	16	71.4	65.10	18	50	10
T 08205	17	75.4	69.11	18	50	10
T 08206	18	79.4	73.14	18	50	10
T 08207	19	83.5	77.16	18	50	10
T 08208	20	87.5	81.19	18	50	10
T 12898	21	91.5	85.22	20	60	12
T 12899	22	95.5	89.24	20	60	12
T 12900	23	99.6	93.27	20	60	12
T 08209	24	103.6	97.29	20	60	12
T 12901	25	107.6	101.33	20	60	12
T 12902	26	111.7	105.36	20	70	16
T 12903	27	115.7	109.40	20	70	16
T 12904	28	119.7	113.42	20	70	16
T 12905	29	123.8	117.46	20	70	16
T 12906	30	127.8	121.50	20	70	16
T 12908	32	135.9	129.56	20	70	16
T 12910	34	143.9	137.64	20	70	16
T 12911	35	148.0	141.68	20	70	16
T 12912	36	152.0	145.72	25	70	16
T 12913	37	156.1	149.76	25	70	16
T 12914	38	160.1	153.80	25	70	16
T 12915	39	164.1	157.83	25	70	16
T 12916	40	168.2	161.87	25	70	16

B1	r3	c	h
3	13	1.3	$z \geq 31 = 4$

Rozmiary w mm.

# Koło łańcuchowe z piastą 1/2"x3/16" (083-1/084-1)

dla łańcucha rolkowego DIN 8187/ ISO R606

Materiał

Stal C 43

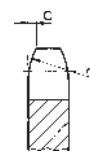
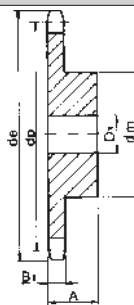
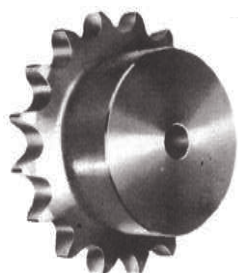

1-rzędowe Kod	Ilość zębów z	de	dp	1-rzędowe		
				A	dm	D1
T 12674	8	39.5	33.18	14	21	8
T 12675	9	43.4	37.13	14	25	8
T 12676	10	47.4	41.10	14	28	8
T 12677	11	51.4	45.07	16	31	8
T 08210	12	55.4	49.07	16	35	8
T 08211	13	59.4	53.06	16	39	8
T 08212	14	63.4	57.07	16	43	8
T 08213	15	67.4	61.09	16	47	8
T 08214	16	71.4	65.10	18	50	10
T 08215	17	75.4	69.11	18	50	10
T 08216	18	79.4	73.14	18	50	10
T 08217	19	83.5	77.16	18	50	10
T 08218	20	87.5	81.19	18	50	10
T 08219	21	91.5	85.22	20	60	12
T 12917	22	95.5	89.24	20	60	12
T 12678	23	99.6	93.27	20	60	12
T 12679	24	103.6	97.29	20	60	12
T 12918	25	107.6	101.33	20	60	12
T 12919	26	111.7	105.36	20	70	16
T 12920	27	115.7	109.40	20	70	16
T 12921	28	119.7	113.42	20	70	16
T 12925	29	123.8	117.46	20	70	16
T 12926	30	127.8	121.50	20	70	16
T 12927	31	131.8	125.54	20	70	16
T 12928	32	135.9	129.56	20	70	16
T 12929	33	139.9	133.60	20	70	16
T 12930	34	143.9	137.64	20	70	16
T 12931	35	148.0	141.68	20	70	16
T 12932	36	152.0	145.72	25	70	16
T 12933	37	156.1	149.76	25	70	16
T 12934	38	160.1	153.80	25	70	16
T 12935	39	164.1	157.83	25	70	16
T 12936	40	168.2	161.87	25	70	16

B1	r3	c
4.5	13	1.3

Rozmiary w mm.

# Koło łańcuchowe z piastą 1/2"x5/16" (08B-1 -2 -3)

dla łańcucha rolkowego DIN 8187/ ISO R606

Materiał

Stal C 43

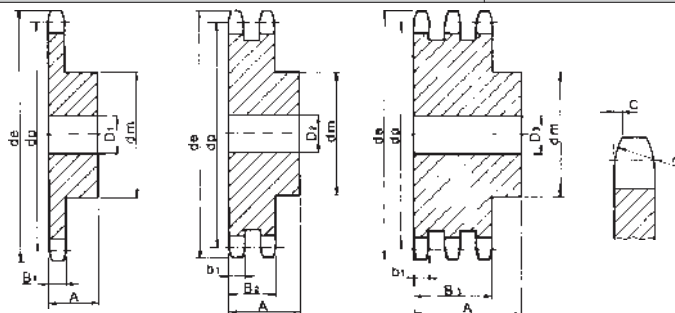
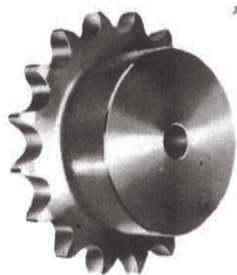

1-rzędowe Kod	2-rzędowe Kod	3-rzędowe Kod	Ilość zębów z	de	dp	1-rzędowe			2-rzędowe			3-rzędowe		
						A	dm	D1	A	dm	D2	A	dm	D3
T 08220	T 12938	T 13780	8	38.0	33.18	25	20	10	32	20	10	46	20	10
T 08221	T 12939	T 13781	9	42.0	37.13	25	24	10	32	24	10	46	24	12
T 08222	T 10874	T 13782	10	45.9	41.10	25	26	10	32	28	10	46	28	12
T 08223	T 12216	T 13783	11	49.9	45.07	25	29	10	35	32	12	50	32	16
T 08224	T 10875	T 13784	12	53.9	49.07	28	33	10	35	35	12	50	35	16
T 08225	T 09393	T 13785	13	57.9	53.06	28	37	10	35	38	12	50	38	16
T 08226	T 12217	T 13786	14	61.9	57.07	28	41	10	35	42	12	50	42	16
T 08227	T 09558	T 13787	15	65.9	61.09	28	45	10	35	46	12	50	46	16
T 08228	T 12940	T 13788	16	69.9	65.10	28	50	12	38	50	16	50	50	16
T 08229	T 09394	T 13789	17	74.0	69.11	28	52	12	38	54	16	50	54	16
T 08230	T 12941	T 13790	18	78.0	73.14	28	56	12	38	58	16	50	58	16
T 08231	T 10876	T 13791	19	82.0	77.16	28	60	12	38	62	16	50	62	16
T 08232	T 09879	T 13792	20	86.0	81.19	28	64	12	38	66	16	50	66	16
T 08233	T 10877	T 13793	21	90.1	85.22	28	68	14	40	70	16	55	70	16
T 08234	T 12218	T 13794	22	94.1	89.24	28	70	14	40	70	16	55	70	16
T 08235	T 12219	T 13795	23	98.1	93.27	28	70	14	40	70	16	55	70	16
T 08236	T 12220	T 13796	24	102.1	97.29	28	70	14	40	75	16	55	75	16
T 08964	T 12221	T 13797	25	106.2	101.33	28	70	14	40	80	16	55	80	16
T 08965	T 12882	T 13798	26	110.2	105.36	30	70	16	40	85	16	55	85	20
T 08237	T 12222	T 13799	27	114.2	109.40	30	70	16	40	85	16	55	85	20
T 09572	T 12223	T 13800	28	118.3	113.42	30	70	16	40	90	16	55	90	20
T 10845	T 12942	T 13801	29	122.3	117.46	30	80	16	40	95	16	55	95	20
T 08238	T 10878	T 13802	30	126.3	121.50	30	80	16	40	100	16	55	100	20
T 09363	T 12943	T 13803	31	130.4	125.54	30	90	16	40	100	20	55	110	20
T 09573	T 12224	T 13804	32	134.4	129.56	30	90	16	40	100	20	55	110	20
T 09574	T 12944	T 13805	33	138.4	133.60	30	90	16	40	100	20	55	110	20
T 08239	T 12225	T 13806	34	142.4	137.64	30	90	16	40	100	20	55	110	20
T 10846	T 12226	T 13807	35	146.5	141.68	30	90	16	40	100	20	55	110	20
T 08966	T 12227	T 13808	36	150.6	145.72	35	90	16	40	100	20	55	120	25
T 10847	T 12229	T 13809	37	154.6	149.76	35	90	16	40	100	20	55	120	25
T 10113	T 12228	T 13810	38	158.6	153.80	35	90	16	40	100	20	55	120	25
T 12937	T 12945	T 13811	39	162.7	157.83	35	90	16	40	100	20	55	120	25
T 09395	T 12230	T 13812	40	166.7	161.87	35	90	16	40	100	20	55	120	25

B1	B2	B3	r3	c	b1
7.2	21	34.9	13	1.3	7

Rozmiary w mm.

# Koło łańcuchowe z piastą 5/8"x3/8" (10B-1 -2 -3) dla łańcucha rolkowego DIN 8187/ ISO R606

Materiał  
Stal C 43 / Fe 410\*

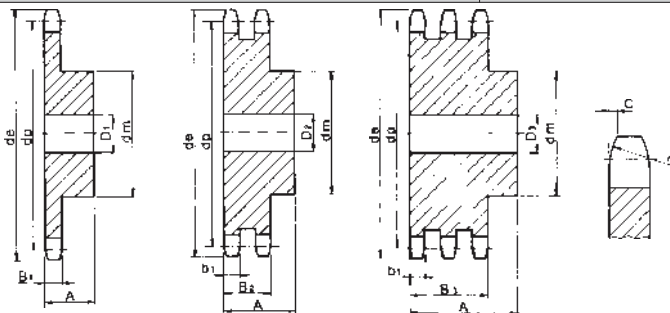
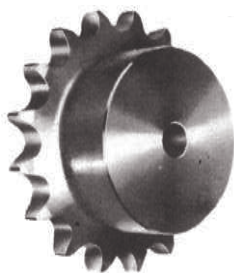

1-rzędowe Kod	2-rzędowe Kod	3-rzędowe Kod	Ilość zębów z	de	dp	1-rzędowe			2-rzędowe			3-rzędowe		
						A	dm	D1	A	dm	D2	A	dm	D3
T 10849	T 12948	T 13813	8	48.4	41.08	25	25	10	40	25	12	55	25	12
T 10850	T 12949	T 13814	9	53.3	46.42	25	30	10	40	30	12	55	30	12
T 08240	T 12232	T 13815	10	58.3	51.37	25	35	10	40	35	12	55	35	16
T 08241	T 08258	T 13816	11	63.2	56.34	30	37	12	40	39	16	55	39	16
T 08242	T 12233	T 13817	12	68.2	61.34	30	42	12	40	44	16	55	44	16
T 08243	T 12234	T 13818	13	73.2	66.32	30	47	12	40	49	16	55	49	16
T 08244	T 08260	T 13819	14	78.2	71.34	30	52	12	40	54	16	55	54	16
T 08245	T 12235	T 13820	15	83.2	76.36	30	57	12	40	59	16	55	59	16
T 08246	T 12950	T 13821	16	88.3	81.37	30	60	12	45	64	16	60	64	16
T 08247	T 12236	T 13822	17	93.3	86.39	30	60	12	45	69	16	60	69	16
T 08248	T 12951	T 13823	18	98.3	91.42	30	70	14	45	74	16	60	74	16
T 08249	T 12237	T 13824	19	103.3	96.45	30	70	14	45	79	16	60	79	16
T 08250	T 08261	T 13825	20	108.4	101.49	30	75	14	45	84	16	60	84	16
T 08251	T 12238	T 13826	21	113.4	106.52	30	75	16	45	85	16	60	85	20
T 08252	T 12239	T 13827	22	118.4	111.55	30	80	16	45	90	16	60	90	20
T 08253	T 12952	T 13828	23	123.5	116.58	30	80	16	45	95	16	60	95	20
T 08254	T 12240	T 13829	24	128.5	121.62	30	80	16	45	100	16	60	100	20
T 10851	T 12241	T 13830	25	133.6	126.66	30	80	16	45	105	16	60	105	20
T 10852	T 12953	T 13831	26	138.6	131.70	35	85	20	45	110	20	60	110	20
T 08255	T 12242	T 13832	27	143.6	136.75	35	85	20	45	110	20	60	110	20
T 09356	T 12954	T 13833	28	148.7	141.78	35	90	20	45	115	20	60	115	20
T 12946	T 12955	T 13834	29	153.7	146.83	35	90	20	45	115	20	60	115	20
T 08256	T 12243	T 13835	30	158.8	151.87	35	90	20	45	120	20	60	120	20
T 10853	T 12956	T 13836	31	163.8	156.92	35	95	20	45	120*	20	60	120*	20
T 10854	T 12244	T 13837	32	168.9	161.95	35	95	20	45	120*	20	60	120*	20
T 10855	T 12957	T 13838	33	173.9	167.00	35	95	20	45	120*	20	60	120*	20
T 10856	T 12958	T 13839	34	178.9	172.05	35	95	20	45	120*	20	60	120*	20
T 08257	T 12959	T 13840	35	184.0	177.10	35	95	20	45	120*	20	60	120*	20
T 10857	T 12960	T 13841	36	189.0	182.15	35	100	20	45	120*	20	60	120*	25
T 10858	T 12961	T 13842	37	194.1	187.20	35	100	20	45	120*	20	60	120*	25
T 10859	T 12962	T 13843	38	199.1	192.24	35	100	20	45	120*	20	60	120*	25
T 12947	T 12963	T 13844	39	204.2	197.29	35	100	20	45	120*	20	60	120*	25
T 10860	T 12964	T 13845	40	209.2	202.34	35	100	20	45	120*	20	60	120*	25

B1	B2	B3	r3	c	b1
9.1	25.5	42.1	16	1.6	9

Rozmiary w mm.

**UWAGA:**

\* z piastą

# Koło łańcuchowe z piastą 3/4"x7/16" (12B -1 -2 -3)

dla łańcucha rolkowego DIN 8187/ ISO R606

Materiał  
Stal C 43 / Fe 410\*

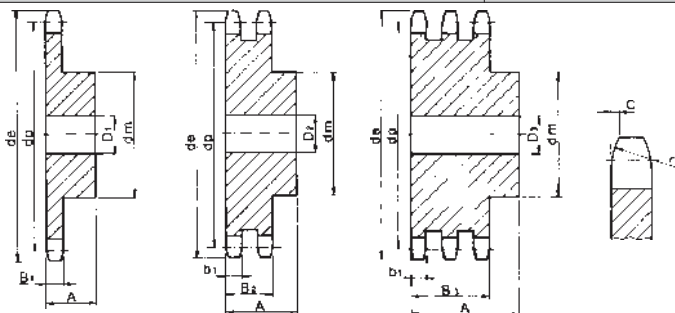
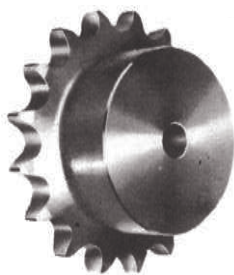

1-rzędowe Kod	2-rzędowe Kod	3-rzędowe Kod	Ilość zębów z	de	dp	1-rzędowe			2-rzędowe			3-rzędowe		
						A	dm	D1	A	dm	D2	A	dm	D3
T 10861	T 13846	T 13879	8	58.0	49.78	30	31	12	45	31	12	65	31	16
T 10862	T 13847	T 13880	9	63.9	55.70	30	37	12	45	37	12	65	37	16
T 10863	T 13848	T 13881	10	69.8	61.64	30	42	12	45	42	12	65	42	16
T 08264	T 13849	T 13882	11	75.8	67.61	35	46	16	50	47	16	70	47	20
T 08265	T 13850	T 13883	12	81.8	73.60	35	52	16	50	53	16	70	53	20
T 08266	T 13851	T 13884	13	87.8	79.59	35	58	16	50	59	16	70	59	20
T 08267	T 13852	T 13885	14	93.8	85.61	35	64	16	50	65	16	70	65	20
T 08268	T 13853	T 13886	15	99.8	91.63	35	70	16	50	71	16	70	71	20
T 08269	T 13854	T 13887	16	105.8	97.65	35	75	16	50	77	20	70	77	20
T 08270	T 13855	T 13888	17	111.9	103.67	35	80	16	50	83	20	70	83	20
T 08271	T 13856	T 13889	18	117.9	109.71	35	80	16	50	89	20	70	89	20
T 08272	T 13857	T 13890	19	123.9	115.75	35	80	16	50	95	20	70	95	20
T 08273	T 13858	T 13891	20	130.0	121.78	35	80	16	50	100	20	70	100	20
T 08274	T 13859	T 13892	21	136.0	127.82	40	90	20	50	100	20	70	100	20
T 08275	T 13860	T 13893	22	142.0	133.86	40	90	20	50	100	20	70	100	20
T 08276	T 13861	T 13894	23	148.1	139.90	40	90	20	50	110	20	70	110	20
T 08277	T 13862	T 13895	24	154.1	145.94	40	90	20	50	110	20	70	110	20
T 10864	T 13863	T 13896	25	160.2	152.00	40	90	20	50	120	20	70	120	20
T 10865	T 13864	T 13897	26	166.2	158.04	40	95	20	50	120	20	70	120	20
T 08278	T 13865	T 13898	27	172.3	164.09	40	95	20	50	120	20	70	120	20
T 10866	T 13866	T 13899	28	178.3	170.13	40	95	20	50	120	20	70	120	20
T 12965	T 13867	T 13900	29	184.4	176.19	40	95	20	50	120	20	70	120	20
T 08279	T 13868	T 13901	30	190.4	182.25	40	95	20	50	120	20	70	120	20
T 09364	T 13869	T 13902	31	196.5	188.31	40	95	20	50	120*	20	70	130*	25
T 10867	T 13870	T 13903	32	202.5	194.35	40	95	20	50	120*	20	70	130*	25
T 10868	T 13871	T 13904	33	208.6	200.40	40	95	20	50	120*	20	70	130*	25
T 10869	T 13872	T 13905	34	214.6	206.46	40	95	20	50	120*	20	70	130*	25
T 10870	T 13873	T 13906	35	220.7	212.52	40	95	20	50	120*	20	70	130*	25
T 10871	T 13874	T 13907	36	226.8	218.58	40	100	20	50	120*	25	70	130*	25
T 12966	T 13875	T 18371	37	232.8	224.64	40	100	20	50	120*	25	70	130*	25
T 10872	T 13876	T 18372	38	238.9	230.69	40	100	20	50	120*	25	70	130*	25
T 12967	T 13877	T 18373	39	244.9	236.75	40	100	20	50	120*	25	70	130*	25
T 10873	T 13878	T 18374	40	251.0	242.81	40	100	20	50	120*	25	70	130*	25

B1	B2	B3	r3	c	b1
11.1	30.3	49.8	19	2	10.8

Rozmiary w mm.

**UWAGA:**

\* z piastą

# Koło łańcuchowe z piastą 1"x17.02 mm(16B-1-2-3) dla łańcucha rolkowego DIN 8187/ ISO R606

Materiał  
Stal C 43 / Fe 410\*

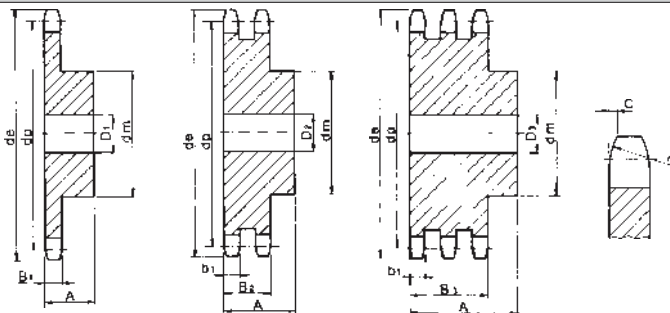
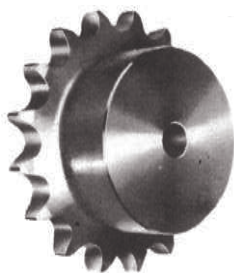

1-rzędowe Kod	2-rzędowe Kod	3-rzędowe Kod	Ilość zębów z	de	dp	1-rzędowe			2-rzędowe			3-rzędowe		
						A	dm	D1	A	dm	D2	A	dm	D3
T 12202	T 13908	T 13941	8	77.9	66.37	35	42	16	65	42	20	95	42	20
T 12968	T 13909	T 13942	9	85.8	74.27	35	50	16	65	50	20	95	50	20
T 12203	T 13910	T 13943	10	93.8	82.19	35	55	16	65	56	20	95	56	20
T 12969	T 13911	T 13944	11	101.7	90.14	40	61	16	70	64	20	100	64	25
T 12970	T 13912	T 13945	12	109.7	98.14	40	69	16	70	72	20	100	72	25
T 12204	T 13913	T 13946	13	117.7	106.12	40	78	16	70	80	20	100	80	25
T 12971	T 13914	T 13947	14	125.7	114.15	40	84	16	70	88	20	100	88	25
T 12205	T 13915	T 13948	15	133.7	122.17	40	92	16	70	96	20	100	96	25
T 12206	T 13916	T 13949	16	141.8	130.20	45	100	20	70	104	20	100	104	25
T 09986	T 13917	T 13950	17	149.8	138.22	45	100	20	70	112	20	100	112	25
T 12207	T 13918	T 13951	18	157.8	146.28	45	100	20	70	120	20	100	120	25
T 12208	T 13919	T 13952	19	165.9	154.33	45	100	20	70	128	20	100	128	25
T 08500	T 13920	T 13953	20	173.9	162.38	45	100	20	70	130	20	100	130	25
T 12209	T 13921	T 13954	21	182.0	170.43	50	110	20	70	130	25	100	130*	25
T 12972	T 13922	T 13955	22	190.1	178.48	50	110	20	70	130*	25	100	130*	25
T 12973	T 13923	T 13956	23	198.1	186.53	50	110	20	70	130*	25	100	130*	25
T 12210	T 13924	T 13957	24	206.2	194.59	50	110	20	70	130*	25	100	130*	25
T 12211	T 13925	T 13958	25	214.2	202.66	50	110	20	70	130*	25	100	130*	25
T 12974	T 13926	T 13959	26	222.3	210.72	50	120	20	70	130*	25	100	130*	30
T 12212	T 13927	T 13960	27	230.4	218.79	50	120	20	70	130*	25	100	130*	30
T 12213	T 13928	T 13961	28	238.4	226.85	50	120	20	70	130*	25	100	130*	30
T 12975	T 13929	T 13962	29	246.5	234.92	50	120	20	70	130*	25	100	130*	30
T 12214	T 13930	T 13963	30	254.6	243.00	50	120	20	70	130*	25	100	130*	30
T 12976	T 13931	T 13964	31	262.6	251.08	50	120*	25	70	140*	25	100	140*	30
T 12215	T 13932	T 13965	32	270.7	259.13	50	120*	25	70	140*	25	100	140*	30
T 12977	T 13933	T 13966	33	278.8	267.21	50	120*	25	70	140*	25	100	140*	30
T 12978	T 13934	T 13967	34	286.9	275.28	50	120*	25	70	140*	25	100	140*	30
T 12673	T 13935	T 13968	35	294.9	283.36	50	120*	25	70	140*	25	100	140*	30
T 12979	T 13936	T 13969	36	303.0	291.44	50	120*	25	70	140*	25	100	140*	30
T 12980	T 13937	-	37	311.1	299.51	50	120*	25	70	140*	25	-	-	-
T 12981	T 13938	T 13971	38	319.2	307.59	50	120*	25	70	140*	25	100	140*	30
T 12982	T 13939	-	39	327.2	315.67	50	120*	25	70	140*	25	-	-	-
T 12983	T 13940	T 13973	40	335.3	323.75	50	120*	25	70	140*	25	100	140*	30

B1	B2	B3	r3	c	b1
16.2	47.7	79.6	26	2.5	15.8

Rozmiary w mm.

**UWAGA:**

\* z piastą

# Koło łańcuchowe z piastą 1 1/4"x3/4"(20B -1 -2 -3) dla łańcucha rolkowego DIN 8187/ ISO R606

Materiał

Stal C 43 / Fe 410\*

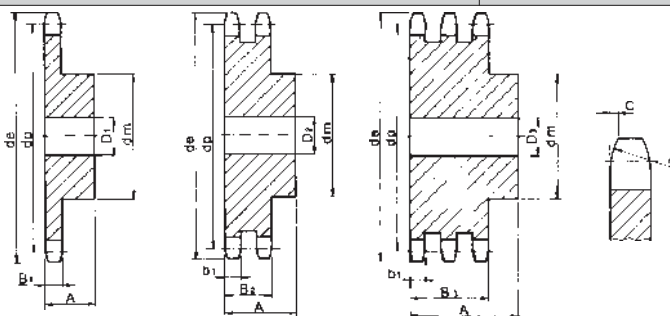
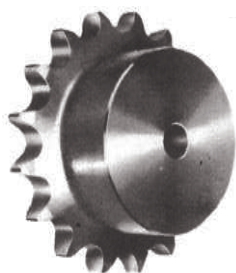

1-rzędowe Kod	2-rzędowe Kod	3-rzędowe Kod	Ilość zębów z	de	dp	1-rzędowe			2-rzędowe			3-rzędowe		
						A	dm	D1	A	dm	D2	A	dm	D3
T 12984	T 13974	T 14007	8	96.0	82.96	40	53	20	75	53	20	110	53	25
T 12985	T 13975	T 14008	9	106.5	92.84	40	63	20	75	63	20	110	63	25
T 12986	T 13976	T 14009	10	117.0	102.74	40	70	20	75	70	20	110	70	25
T 12987	T 13977	T 14010	11	127.0	112.68	45	77	20	80	80	25	115	80	30
T 12988	T 13978	T 14011	12	137.0	122.68	45	88	20	80	90	25	115	90	30
T 12989	T 13979	T 14012	13	147.5	132.65	45	98	20	80	100	25	115	100	30
T 11269	T 13980	T 14013	14	157.6	142.68	45	108	20	80	110	25	115	110	30
T 12990	T 13981	T 14014	15	167.7	152.72	45	118	20	80	120	25	115	120	30
T 12991	T 13982	T 14015	16	177.7	162.75	50	120	25	80	120	30	115	120	30
T 10555	T 13983	T 14016	17	187.7	172.78	50	120	25	80	120	30	115	120	30
T 10556	T 13984	T 14017	18	197.8	182.85	50	120	25	80	120*	30	115	120*	30
T 12992	T 13985	T 14018	19	207.9	192.91	50	120	25	80	120*	30	115	120*	30
T 12993	T 13986	T 14019	20	217.9	202.98	50	120	25	80	120*	30	115	120*	30
T 12994	T 13987	T 14020	21	228.0	213.04	55	140	25	80	140*	30	115	140*	30
T 12995	T 13988	T 14021	22	238.1	223.11	55	140	25	80	140*	30	115	140*	30
T 12996	T 13989	T 14022	23	248.2	233.17	55	140	25	80	140*	30	115	140*	30
T 12997	T 13990	T 14023	24	258.3	243.23	55	140	25	80	140*	30	115	140*	30
T 12998	T 13991	T 14024	25	268.4	253.33	55	140	25	80	140*	30	115	140*	30
T 12999	T 13992	T 14025	26	278.4	263.40	55	150*	30	80	150*	30	115	150*	30
T 13000	T 13993	T 14026	27	288.5	273.48	55	150*	30	80	150*	30	115	150*	30
T 13058	T 13994	T 14027	28	298.5	283.56	55	150*	30	80	150*	30	115	150*	30
T 13059	T 13995	-	29	308.6	293.65	55	150*	30	80	150*	30	-	-	-
T 13060	T 13996	T 14029	30	318.7	303.65	55	150*	30	80	150*	30	115	150*	30
T 13061	T 13997	-	31	328.8	313.85	55	150*	30	80	150*	30	-	-	-
T 13062	T 13998	T 14031	32	338.9	323.91	55	150*	30	80	150*	30	115	150*	30
T 13063	-	T 14032	33	349.0	334.01	55	150*	30	-	-	-	115	150*	30
T 13064	T 14000	T 14033	34	359.1	344.10	55	150*	30	80	150*	30	115	150*	30
T 13065	T 14001	T 14034	35	369.2	354.20	55	150*	30	80	150*	30	115	150*	30
T 13066	T 14002	T 14035	36	379.2	364.30	55	150*	30	80	150*	30	115	150*	30
T 13067	-	-	37	389.3	374.39	55	150*	30	-	-	-	-	-	-
T 13068	T 14004	T 14037	38	399.4	384.49	55	150*	30	80	150*	30	115	150*	30
T 13069	-	-	39	409.5	394.59	55	150*	30	-	-	-	-	-	-
T 13070	T 14006	T 14039	40	419.6	404.66	55	150*	30	80	150*	30	115	150*	30

B1	B2	B3	r3	c	b1
18.5	54.6	91	32	3.5	18.2

Rozmiary w mm.

**UWAGA:**

\* z piastą

# Koło łańcuchowe z piastą 1 1/2" x 1" (24B -1 -2 -3) dla łańcucha rolkowego DIN 8187/ ISO R606

Materiał

Stal C 43 / Fe 410\*

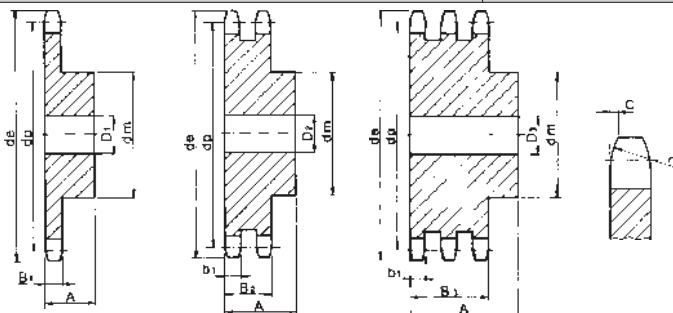
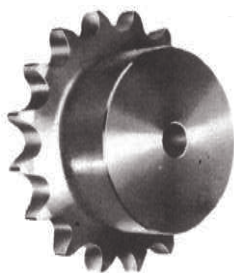

1-rzędowe Kod	2-rzędowe Kod	3-rzędowe Kod	Ilość zębów z	de	dp	1-rzędowe			2-rzędowe			3-rzędowe		
						A	dm	D1	A	dm	D2	A	dm	D3
T 14040	T 14073	T 14106	8	113.0	99.55	45	58	20	95	58	25	140	58	25
T 14041	T 14074	T 14107	9	125.0	111.40	45	70	20	95	70	25	140	70	25
T 14042	T 14075	T 14108	10	137.0	123.29	45	80	20	95	80	25	140	80	25
T 14043	T 14076	T 14109	11	149.0	135.21	50	90	25	100	90	25	150	90	30
T 14044	T 14077	T 14110	12	161.0	147.22	50	102	25	100	102	25	150	102	30
T 14045	T 14078	T 14111	13	173.0	159.18	50	114	25	100	114	25	150	114	30
T 14046	T 14079	T 14112	14	185.0	171.22	50	128	25	100	128	25	150	128	30
T 14047	T 14080	T 14113	15	197.0	183.26	50	132	25	100	132	25	150	132	30
T 14048	T 14081	T 14114	16	209.0	195.30	55	136*	25	100	136*	30	150	136*	30
T 14049	T 14082	T 14115	17	221.0	207.34	55	136*	25	100	136*	30	150	136*	30
T 14050	T 14083	T 14116	18	233.0	219.42	55	136*	25	100	160*	30	150	160*	30
T 14051	T 14084	T 14117	19	245.5	231.49	55	136*	25	100	160*	30	150	160*	30
T 14052	T 14085	T 14118	20	257.5	243.57	55	136*	25	100	160*	30	150	160*	30
T 14053	T 14086	T 14119	21	270.5	255.65	60	150*	30	100	160*	30	150	160*	40
T 14054	T 14087	T 14120	22	282.5	267.73	60	150*	30	100	160*	30	150	160*	40
T 14055	T 14088	T 14121	23	294.5	279.80	60	150*	30	100	160*	30	150	160*	40
T 14056	T 14089	T 14122	24	307.0	291.88	60	150*	30	100	160*	30	150	160*	40
T 14057	T 14090	T 14123	25	319.0	304.00	60	150*	30	100	160*	30	150	160*	40
T 14058	T 14091	T 14124	26	331.0	316.08	60	150*	30	100	160*	30	150	160*	40
T 14059	T 14092	T 14125	27	343.0	328.19	60	150*	30	100	160*	30	150	160*	40
T 14060	T 14093	T 14126	28	355.0	340.27	60	150*	30	100	160*	30	150	160*	40
T 14061	T 14094	-	29	367.5	352.38	60	150*	30	100	160*	30	-	-	-
T 14062	T 14095	T 14128	30	379.5	364.50	60	150*	30	100	160*	30	150	160*	40
T 14063	T 14096	-	31	391.5	376.62	60	150*	30	100	160*	40	-	-	-
T 14064	T 14097	T 14130	32	403.5	388.69	60	150*	30	100	160*	40	150	160*	40
T 14065	T 14098	-	33	415.5	400.81	60	150*	30	100	160*	40	-	-	-
T 14066	T 14099	-	34	428.0	412.83	60	150*	30	100	160*	40	-	-	-
T 14067	T 14100	T 14133	35	440.0	425.04	60	150*	30	100	160*	40	150	160*	40
T 14068	T 14101	-	36	452.0	437.16	60	150*	30	100	160*	40	-	-	-
T 14069	T 14102	-	37	464.0	449.27	60	150*	30	100	160*	40	-	-	-
T 14070	T 14103	T 14136	38	476.5	461.39	60	150*	30	100	160*	40	150	160*	40
T 14072	T 14105	T 14138	40	501.5	485.62	60	150*	30	100	160*	40	150	160*	40

B1	B2	B3	r3	c	b1
24.1	72	120.3	38	4	23.6

Rozmiary w mm.

**UWAGA:**

\* z piastą

# Koło łańcuchowe z piastą 3/4"x1 1/4" (28B-1-2-3) dla łańcucha rolkowego DIN 8187/ ISO R606

Materiał

Stal C 43 / Fe 410\*

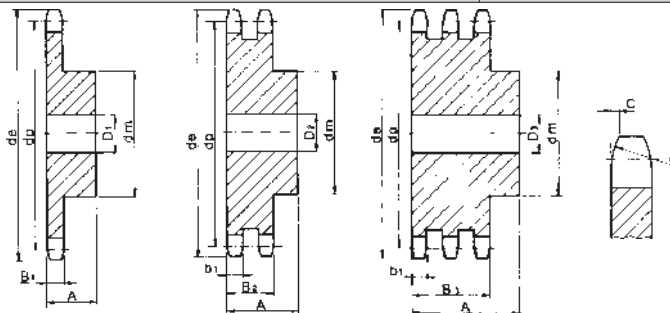
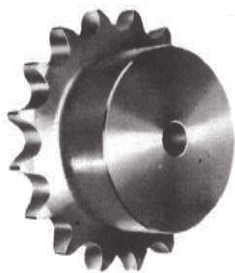

1-rzędowe Kod	2-rzędowe Kod	3-rzędowe Kod	Ilość zębów z	de	dp	1-rzędowe			2-rzędowe			3-rzędowe		
						A	dm	D1	A	dm	D2	A	dm	D3
Na zapytanie	Na zapytanie	Na zapytanie	8	132.0	116.15	70	74	25	120	74	30	180	74	30
			9	146.0	129.96	70	88	25	120	88	30	180	88	30
			10	160.0	143.85	70	100	25	120	100	30	180	100	30
			11	174.0	157.77	70	112	25	120	112	30	180	112	30
			12	188.0	171.74	70	125	25	120	125	30	180	125	30
			13	204.0	185.75	70	125*	25	120	125*	30	180	125*	30
			14	218.0	199.76	70	125*	25	120	125*	30	180	125*	30
			15	232.0	213.79	70	125*	25	120	145*	30	180	145*	30
			16	246.0	227.84	75	160*	30	120	160*	30	180	160*	30
			17	260.0	241.90	75	160*	30	120	160*	30	180	160*	30
			18	274.0	255.98	75	160*	30	120	160*	30	180	160*	30
			19	289.0	270.06	75	160*	30	120	180*	30	180	180*	30
			20	303.0	284.15	75	160*	30	120	180*	30	180	180*	30
			21	317.0	298.24	75	160*	30	120	180*	30	180	180*	40
			22	331.0	312.34	75	160*	30	120	180*	30	-	-	-
			23	345.0	326.44	75	160*	30	120	180*	30	180	180*	40
			24	359.0	340.55	75	160*	30	-	-	-	-	-	-
			25	373.0	354.66	75	160*	30	120	180*	30	180	180*	40
			26	387.0	368.77	75	160*	30	120	180*	40	-	-	-
			27	401.0	382.88	75	160*	30	-	-	-	-	-	-
28	416.0	397.00	75	160*	30	120	180*	40	-	-	-			
30	444.0	425.24	75	160*	30	120	180*	40	180	180*	40			
32	472.0	453.49	75	180*	30	-	-	-	-	-	-			
34	500.0	481.75	75	180*	30	-	-	-	-	-	-			
35	514.0	495.88	75	180*	30	120	200*	40	-	-	-			
36	529.0	510.01	75	180*	30	-	-	-	-	-	-			
38	557.0	538.27	75	180*	30	120	200*	40	180	200*	40			
40	585.0	566.54	75	180*	30	120	200*	40	180	200*	40			

B1	B2	B3	r3	c	b1
29.4	88.4	148	44	5	28.8

Rozmiary w mm.

**UWAGA:**

\* z piastą

# Koło łańcuchowe z piastą 2" x 1 1/4" (32B -1 -2 -3) dla łańcucha rolkowego DIN 8187/ ISO R606

Materiał

Stal C 43 / Fe 410\*

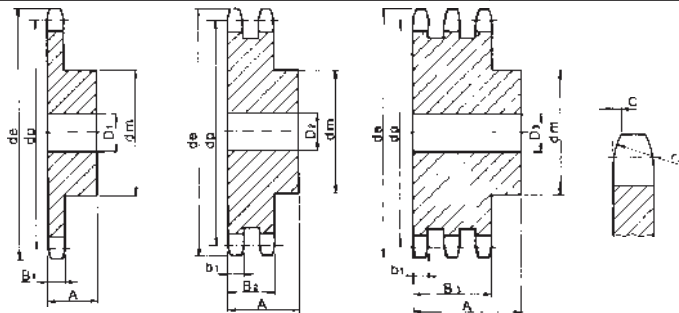
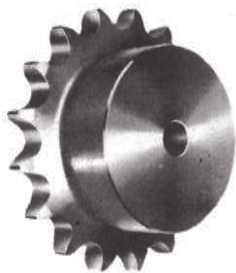

1-rzędowe Kod	2-rzędowe Kod	3-rzędowe Kod	Ilość zębów z	de	dp	1-rzędowe			2-rzędowe			3-rzędowe		
						A	dm	D1	A	dm	D2	A	dm	D3
Na zapytanie	Na zapytanie	Na zapytanie	8	152.0	132.74	80	85	30	120	85	30	180	85	30
			9	168.0	148.54	80	100	30	120	100	30	180	100	30
			10	184.0	164.39	80	115	30	120	115	30	180	115	30
			11	200.0	181.31	80	125	30	120	125	35	180	125	35
			12	216.0	196.29	80	133*	30	120	133*	35	180	133*	35
			13	235.0	212.29	80	145*	30	120	145*	35	180	145*	35
			14	251.0	228.29	80	145*	30	120	145*	35	180	145*	35
			15	267.0	244.30	80	145*	30	120	160*	35	180	160*	35
			16	283.0	260.40	90	160*	30	120	160*	40	180	160*	40
			17	299.0	276.46	90	160*	30	120	180*	40	180	200*	40
			18	315.0	292.55	90	160*	30	120	180*	40	180	200*	40
			19	331.0	308.66	90	160*	30	120	200*	40	180	200*	40
			20	347.0	324.71	90	180*	40	120	200*	40	180	200*	40
			21	363.0	340.82	90	180*	40	120	200*	40	180	200*	40
			22	379.0	356.98	90	180*	40	120	200*	40	-	-	-
			23	396.0	373.08	90	180*	40	120	200*	40	180	200*	40
			24	412.0	389.18	90	180*	40	120	200*	40	-	-	-
			25	428.0	405.33	90	180*	40	120	200*	40	180	200*	40
			26	444.0	421.44	90	180*	40	120	200*	40	-	-	-
			28	476.0	453.69	90	180*	40	120	200*	40	-	-	-
30	508.0	486.00	90	180*	40	120	200*	40	180	200*	40			
32	541.0	518.27	90	200*	40	-	-	-	-	-	-			
35	589.0	566.71	90	200*	40	-	-	-	-	-	-			
38	638.0	615.16	90	200*	40	-	-	-	-	-	-			
40	670.0	647.47	90	200*	40	-	-	-	-	-	-			

B1	B2	B3	r3	c	b1
29.4	87.4	146	51	6	28.8

Rozmiary w mm.

**Uwaga:**

\* z piastą