



Tuleje mocujące BK

BK 11 Samocentrujące

Na wysokie momenty skręcające

Tolerancja : wał h8 - piasta H8

Chropowatość powierzchni : R_t max. 16 μ m

Odchyłka osiowa: 0.02 do 0.04 mm

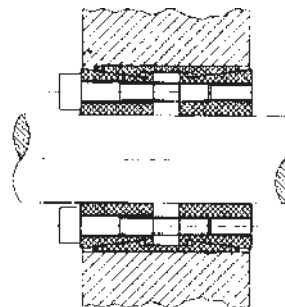

BK 13 Samocentrujące

Na średnie i wyższe momenty skręcające

Tolerancje : wał h8 - piasta H8

Chropowatość powierzchni: R_t max. 16 μ m

Odchyłka osiowa: 0,02 do 0,04 mm

Przy montażu może dojść do niewielkiego osiowego przesunięcia między piastą i wałem



BK 15 Samocentrujące

Na średnie i wyższe momenty skręcające

Tolerancje : wał h8 - piasta H8

Chropowatość powierzchni: R_t max. 16 μ m

Odchyłka osiowa: 0,02 do 0,04 mm

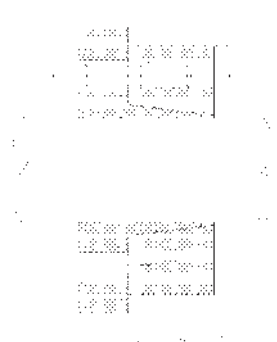



BK 16 Samocentrujące

Na średnie i wyższe momenty skręcające

Tolerancje : wał h8 - piasta H8

Chropowatość: R_t max. 16 μ m

Odchyłka osiowa: 0,02 do 0,04 mm

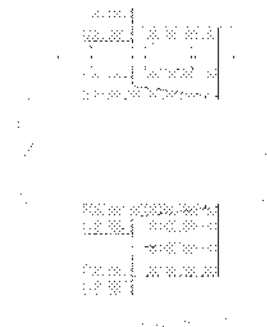

BK 19 Samocentrujące

Na średnie i wyższe momenty skręcające

Tolerancje : wymiar d h8

Tolerancje : wymiar dw

od 18mm do 30 H6/j6

od 30mm do 50mm H6/h6

od 50mm do 80mm H6/g6

od 80mm do 500mm H7/g6

Chropowatość powierzchni: R_t max. 16 μ m

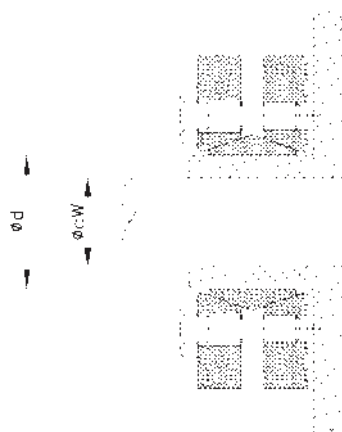

BK 25 Samocentrujące

BK 26 Samocentrujące

Na niskie i średnie momenty skręcające

Tolerancje: wał h8 - piasta H8

Chropowatość powierzchni: R_t max. 16 μ m

Szybki montaż i demontaż

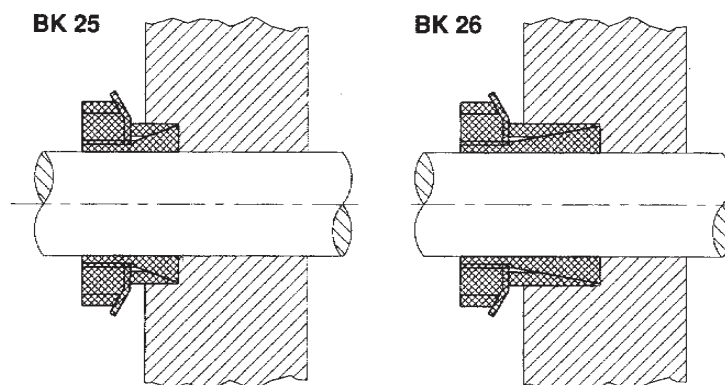



BK 40 Niesamocentrujące

Na średnie i wyższe momenty skręcające

Tolerancje: wał h11 - piasta H11

Chropowatość powierzchni: R_t max. 16 μ m

Szybki demontaż

Dla osiągnięcia współosiowości ważne jest wykonanie otworu prowadzącego piastę

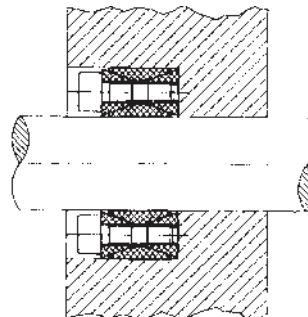

BK 50 Niesamocentrujące

Na niskie i średnie momenty skręcające

Tolerancje:

do \varnothing 40: wał h6 - piasta H7

ponad \varnothing 40: wał h8 - piasta H8

Chropowatość powierzchni: R_t max. 16 μ m

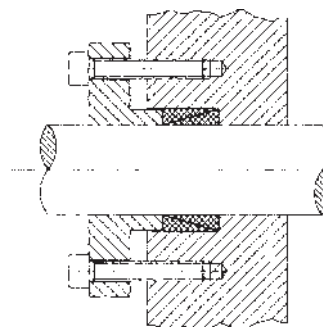

BK 61 Samocentrujące

Na średnie i wyższe momenty skręcające

Tolerancje: wał h8 - piasta H8

Chropowatość powierzchni: R_t max. 16 μ m

Odchyłka osiowa: 0,02 do 0,04 mm

Przy montażu może dojść do niewielkiego osiowego przesunięcia między piastą a wałem

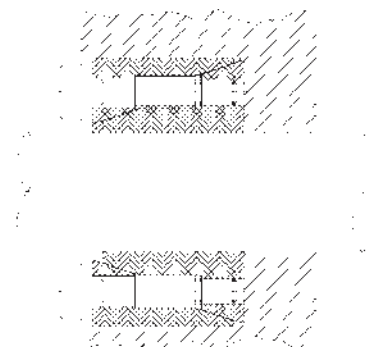

BK 70 Samocentrujące

Na wyższe momenty skręcające

Tolerancje: wał h8 - piasta H8

Chropowatość: R_t max. 16 μ m

Odchyłka osiowa: 0.02 do 0.04 mm

Szybki montaż

Przy montażu może dojść do niewielkiego osiowego przesunięcia między piastą i wałkiem.

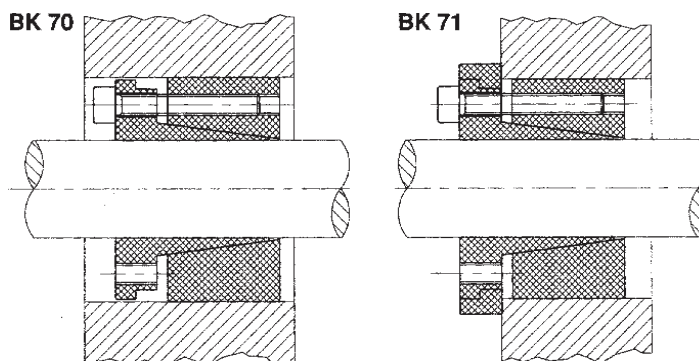

BK 71 Samocentrujące

Na wysokie momenty skręcające

Tolerancje : wał h8 - piasta H8

Chropowatość powierzchni: R_t max. 16 μ m

Odchyłka osiowa : 0.02 aż 0.04 mm

Szybki montaż

BK 80 Samocentrujące

Na średnie i wyższe momenty skręcające

Tolerancje: wał h8 - piasta H8

Chropowatość powierzchni: R_t max. 16 μ m

Odchyłka osiowa: 0.02 aż 0.04 mm

Szybki montaż , przeznaczone na małe wymiary wałków i otworów, maksymalny dociski przy małej powierzchni styku.

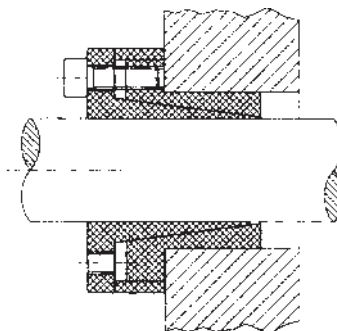

Tuleje mocujące BK samocentrujące

Materiał

Stal C 43

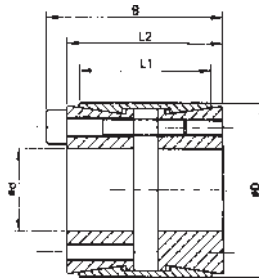

BK 11

Kod	d x D	L1	L2	B	Obrot. moment Nm	Osiowa siła kN	Nacisk na		Śruby mocujące	
							Wątek N/mm ²	Piasta N/mm ²	DIN 912 Typ	Dociąg. mom. Nm
T 78188	25 x 50	39	45	51	950	76	245	122	8 x M 6	17
T 78202	30 x 55	39	45	51	1150	76	204	111	8 x M 6	17
T 78203	35 x 60	39	45	51	1340	76	175	102	8 x M 6	17
T 78204	38 x 65	39	45	51	1450	76	161	94	8 x M 6	17
T 78205	40 x 75	39	45	51	1530	76	153	94	8 x M 6	17
T 78206	42 x 75	56	64	72	2970	141	188	105	8 x M 8	41
T 78207	45 x 75	56	64	72	3150	141	175	105	8 x M 8	41
T 78208	48 x 80	56	64	72	4000	166	164	98	8 x M 8	41
T 78209	50 x 80	56	64	72	4150	166	158	98	8 x M 8	41
T 78210	55 x 85	56	64	72	4550	166	143	93	8 x M 8	41
T 78211	60 x 90	56	64	72	6200	207	164	109	10 x M 8	41
T 78212	65 x 95	56	64	72	6750	207	152	104	10 x M 8	41
T 78213	70 x 110	70	78	88	11550	330	179	114	10 x M10	83
T 78214	75 x 115	70	78	88	12350	330	167	109	10 x M10	83
T 78215	80 x 120	70	78	88	15800	396	188	125	12 x M10	83
T 78216	85 x 125	70	78	88	16800	396	177	120	12 x M10	83
T 78217	90 x 130	70	78	88	17800	396	167	115	12 x M10	83
T 78218	95 x 135	70	78	88	18800	396	158	111	12 x M10	83
T 78219	100 x 145	90	100	112	28800	576	170	117	12 x M12	145

Rozmiary w mm.

Tuleje mocujące BK samocentrujące

Material

Stal C 43



BK 13

Kod	d x D	L1	L2	L3	B	Obrot. moment Nm	Osiowa siła kN	Nacisk na		Śruby mocujące	
								Walek N/mm ²	Piasta N/mm ²	DIN 912 Typ	Dociąg. mom. Nm
F06980	18 x 47	17	22	28	34	330	38	326	125	5 x M 6	14
F06981	19 x 47	17	22	28	34	350	38	308	125	5 x M 6	14
F06982	20 x 47	17	22	28	34	380	38	295	125	5 x M 6	14
F06983	22 x 47	17	22	28	34	410	38	270	125	5 x M 6	14
F06984	24 x 50	17	22	28	34	450	38	245	120	5 x M 6	14
F06985	25 x 50	17	22	28	34	570	46	285	140	6 x M 6	14
F06986	28 x 55	17	22	28	34	630	46	255	130	6 x M 6	14
F06987	30 x 55	17	22	28	34	660	46	235	130	6 x M 6	14
F06988	32 x 60	17	22	28	34	970	60	295	155	8 x M 6	14
F06989	35 x 60	17	22	28	34	1060	60	270	155	8 x M 6	14
F06990	38 x 65	17	22	28	34	1150	60	250	145	8 x M 6	14
F06991	40 x 65	17	22	28	34	1210	60	235	145	8 x M 6	14
F06992	42 x 75	20	25	33	41	2050	98	300	170	7 x M 8	35
F06993	45 x 75	20	25	33	41	2200	98	290	170	7 x M 8	35
F06994	48 x 80	20	25	33	41	2350	98	270	160	7 x M 8	35
F06995	50 x 80	20	25	33	41	2450	98	260	160	7 x M 8	35
F06996	55 x 85	20	25	33	41	3080	112	270	175	8 x M 8	35
F06997	60 x 90	20	25	33	41	3360	112	245	165	8 x M 8	35
F06998	65 x 95	20	25	33	41	4090	126	255	175	9 x M 8	35
F06999	70 x 110	24	30	40	50	6300	179	280	180	8 x M 10	70
F07000	75 x 115	24	30	40	50	6700	179	260	170	8 x M 10	70
F07001	80 x 120	24	30	40	50	7150	179	250	170	8 x M 10	70
F07002	85 x 125	24	30	40	50	8500	200	260	180	9 x M 10	70
F07003	90 x 130	24	30	40	50	9100	200	250	170	9 x M 10	70
F07004	95 x 135	24	30	40	50	10600	224	260	180	10 x M 10	70
F07005	100 x 145	26	32	44	56	13400	268	270	190	8 x M 12	125
F07006	110 x 155	26	32	44	56	14600	268	240	180	8 x M 12	125
F07007	120 x 165	26	32	44	56	17900	298	250	180	9 x M 12	125
F07008	130 x 180	34	40	54	68	26000	400	240	170	12 x M 12	125
F07009	140 x 190	34	40	54	68	27000	384	210	150	9 x M 14	190
F07010	150 x 200	34	40	54	68	33000	440	230	170	10 x M 14	190
F07011	160 x 210	34	40	54	68	38000	479	230	170	11 x M 14	190
F07012	170 x 225	44	50	64	78	45000	530	180	130	12 x M 14	190
F07013	180 x 235	44	50	64	78	47000	530	170	130	12 x M 14	190
F07014	190 x 250	44	50	64	78	62900	660	210	150	15 x M 14	190
F07015	200 x 260	44	50	64	78	66000	660	190	150	15 x M 14	190
F07016	220 x 285	50	56	72	88	98000	891	215	166	12 x M 16	355

Rozmiary w mm.

Tuleje mocujące BK samocentrujące

Material

Stal C 43



BK 15

Kod	d x D	L1	L2	L3	B	D1	Obrot. moment Nm	Osiowa siła kN	Nacisk na		Śruby mocujące	
									Wałek N/mm ²	Piasta N/mm ²	DIN 912 Typ	Dociąg. mom.Nm
F07017	14 x 55	17	22	30	38	62	120	18	205	55	3 x M 8	25
F07018	15 x 55	17	22	30	38	62	130	19	200	55	3 x M 8	25
F07019	16 x 55	17	22	30	38	62	140	18	180	55	3 x M 8	25
F07020	17 x 55	17	22	30	38	62	145	19	176	55	3 x M 8	25
F07021	18 x 55	17	22	30	38	62	150	18	160	55	3 x M 8	25
F07022	19 x 55	17	22	30	38	62	160	18	150	55	3 x M 8	25
F07023	20 x 55	17	22	30	38	62	170	18	145	55	3 x M 8	25
F07024	22 x 55	17	22	30	38	62	280	25	185	75	3 x M 8	35
F07025	24 x 55	17	22	30	38	62	300	25	170	75	3 x M 8	35
F07026	25 x 55	17	22	30	38	62	310	25	165	75	3 x M 8	35
F07027	28 x 55	17	22	30	38	62	430	31	175	90	3 x M 8	41
F07028	30 x 55	17	22	30	38	62	470	31	165	90	3 x M 8	41
F07029	24 x 65	17	22	30	38	72	440	37	244	90	5 x M 8	30
F07030	25 x 65	17	22	30	38	72	460	37	234	90	5 x M 8	30
F07031	28 x 65	17	22	30	38	72	600	44	243	105	5 x M 8	35
F07032	30 x 65	17	22	30	38	72	640	44	227	105	5 x M 8	35
F07033	32 x 65	17	22	30	38	72	690	44	213	105	5 x M 8	35
F07034	35 x 65	17	22	30	38	72	910	52	234	126	5 x M 8	41
F07035	38 x 65	17	22	30	38	72	990	52	216	126	5 x M 8	41
F07036	40 x 65	17	22	30	38	72	1050	52	205	126	5 x M 8	41
F07037	30 x 80	20	25	33	41	87	780	52	232	87	7 x M 8	30
F07038	32 x 80	20	25	33	41	87	830	52	217	87	7 x M 8	30
F07039	35 x 80	20	25	33	41	87	1060	61	232	102	7 x M 8	35
F07040	38 x 80	20	25	33	41	87	1150	61	214	102	7 x M 8	35
F07041	40 x 80	20	25	33	41	87	1220	61	203	102	7 x M 8	35
F07042	42 x 80	20	25	33	41	87	1540	73	233	122	7 x M 8	41
F07043	45 x 80	20	25	33	41	87	1650	73	217	122	7 x M 8	41
F07044	48 x 80	20	25	33	41	87	1760	73	203	122	7 x M 8	41
F07045	50 x 80	20	25	33	41	87	1830	73	195	122	7 x M 8	41

Rozmiary w mm.

Tuleje mocujące BK samocentrujące

Material

Stal C 43

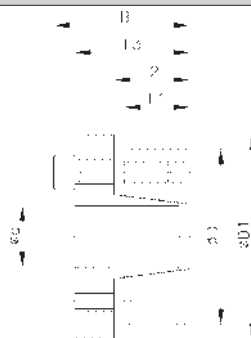

BK 16

Kod	d x D	L1	L2	L3	B	D1	Obrot. moment Nm	Osiowa siła kN	Nacisk na		Śruby mocujące	
									Wałek N/mm ²	Piasta N/mm ²	DIN 912 Typ	Dociąg. mom.Nm
F07046	20 x 47	17	22	28	34	54	280	28	220	95	5 x M6	17
F07047	22 x 47	17	22	28	34	54	300	28	200	95	5 x M6	17
F07048	24 x 50	17	22	28	34	57	330	28	180	90	5 x M6	17
F07049	25 x 50	17	22	28	34	57	420	34	210	105	6 x M6	17
F07050	28 x 55	17	22	28	34	62	470	34	190	95	6 x M6	17
F07051	30 x 55	17	22	28	34	62	500	34	175	95	6 x M6	17
F07052	32 x 60	17	22	28	34	67	720	45	220	115	8 x M6	17
F07053	35 x 60	17	22	28	34	67	790	45	200	115	8 x M6	17
F07054	38 x 65	17	22	28	34	72	850	45	185	105	8 x M6	17
F07055	40 x 65	17	22	28	34	72	900	45	175	105	8 x M6	17
F07056	42 x 75	20	25	33	41	82	1530	73	225	125	7 x M8	41
F07057	45 x 75	20	25	33	41	82	1650	73	215	125	7 x M8	41
F07058	48 x 80	20	25	33	41	87	1760	73	200	120	7 x M8	41
F07059	50 x 80	20	25	33	41	87	1830	73	195	120	7 x M8	41
F07060	55 x 85	20	25	33	41	92	2300	83	200	130	8 x M8	41
F07061	60 x 90	20	25	33	41	97	2510	83	185	125	8 x M8	41
F07062	65 x 95	20	25	33	41	102	3060	94	190	130	9 x M8	41
F07063	70 x 110	24	30	40	50	117	4670	133	210	135	8 x M10	83
F07064	75 x 115	24	30	40	50	122	5000	133	195	125	8 x M10	83
F07065	80 x 120	24	30	40	50	127	5300	133	185	125	8 x M10	83
F07066	85 x 125	24	30	40	50	132	6300	148	195	135	9 x M10	83
F07067	90 x 130	24	30	40	50	137	6750	148	185	130	9 x M10	83
F07068	95 x 135	24	30	40	50	142	7900	166	195	135	10 x M10	83
F07069	100 x 145	26	32	44	56	152	9700	194	200	140	8 x M12	145
F07070	110 x 155	26	32	44	56	162	10600	194	180	130	8 x M12	145
F07071	120 x 165	26	32	44	56	172	13000	216	185	135	9 x M12	145
F07072	130 x 180	34	40	54	66	187	18900	290	175	125	12 x M12	145
F07073	140 x 190	34	40	54	68	197	20500	290	165	120	9 x M14	230
F07074	150 x 200	34	40	54	68	207	25000	333	175	130	10 x M14	230
F07075	160 x 210	34	40	54	68	217	29000	362	180	135	11 x M14	230
F07076	170 x 225	44	50	64	78	232	34000	400	140	105	12 x M14	230
F07077	180 x 235	44	50	64	78	242	36000	400	135	105	12 x M14	230
F07078	190 x 250	44	50	64	78	257	47500	500	160	120	15 x M14	230
F07079	200 x 260	44	50	64	78	267	50000	500	150	115	15 x M14	230
F07080	220 x 285	50	56	72	88	292	61000	556	134	103	12 x M16	355

Rozmiary w mm.

Tuleje mocujące BK samocentrujące

Material

Stal C 43

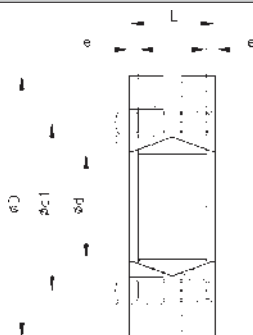

BK 19

Kod	d	dw	D	I	L	d1	e	Obrot. moment Nm	Osiowa siła kN	Śruby mocujące	
										DIN 931(10,9) Typ	Dociąg. mom.Nm
F07081	18	15	43	11	15	28	2	90	12	5 x M 5*	4
								105	13		
								170	25		
F07082	24	20	50	14	19,5	36	2,75	210	27	6 x M 5*	4
								250	29		
								300	29		
F07083	30	25	60	16	21,5	44	2,75	340	31	7 x M 5*	4
								380	33		
								440	50		
F07084	36	30	72	18	23,5	52	2,75	570	58	5 x M 6	12
								630	58		
								620	64		
F07085	44	35	80	20	25,5	61	2,75	780	74	7 x M 6	12
								860	77		
								940	79		
F07086	50	40	90	22	27,5	70	2,75	1160	86	8 x M 6	12
								1380	92		
								1160	79		
F07087	55	45	100	23	30,5	75	3,75	1520	88	8 x M 6	12
								1880	97		
								1850	100		
F07088	62	50	110	23	30,5	86	3,75	2200	111	10 x M 6	12
								2400	117		
								2000	97		
F07089	68	55	115	23	30,5	86	3,75	2500	106	10 x M 6	12
								3150	120		
								2500	119		
F07090	75	60	138	25	32,5	100	3,75	3200	137	7 x M 8	30
								3950	155		
								3200	124		
F07091	80	65	145	25	32,5	100	3,75	3900	140	7 x M 8	30
								4600	158		
								4750	170		
F07092	90	70	155	30	39	114	4,5	6000	190	10 x M 8	30
								7250	210		
								6900	195		
F07093	100	75	170	34	44	124	5	7500	220	12 x M 8	30
								9000	240		
								7200	229		
F07094	110	80	185	39	50	136	5,5	9000	252	9 x M 10	59
								10800	262		
								11000	296		
F07095	125	90	215	42	54	160	6	13000	324	12 x M 10	59
								15000	352		
								15100	367		
F07096	140	100	230	46	60,5	175	7,25	17600	396	10 x M 12	100
								20100	425		
								22000	447		
F07097	155	110	265	50	64,5	192	7,25	25000	478	12 x M 12	100
								28000	509		
								31000	595		
F07098	165	120	290	56	71	210	7,5	35000	630	8 x M 16	250
								39000	655		
								36000	605		
F07099	175	130	300	56	71	220	7,5	41000	639	8 x M 16	250
								45000	675		

Rozmiary w mm.

UWAGA:

* DIN 931 (8,8)

Tuleje mocujące BK

Material

Stal C 43

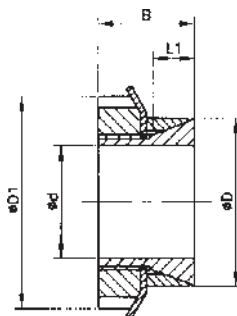

BK 25

Kod	d x D	L1	B	D1	Obrot. moment Nm	Osiowa siła kN	Nacisk na		Śruby mocujące	
							Wątek N/mm ²	Piasta N/mm ²	Śruba Typ	Dociąg. mom. Nm
T 78220	14 x 25	6.5	16.5	32	38	5	200	110	KM 4	95
T 78222	15 x 25	6.5	16.5	32	41	5	185	110	KM 4	95
T 78223	16 x 25	6.5	16.5	32	43	5	174	110	KM 4	95
T 78224	17 x 30	6.5	18.0	38	55	6	197	112	KM 5	160
T 78225	18 x 30	6.5	18.0	38	58	6	186	112	KM 5	160
T 78226	19 x 30	6.5	18.0	38	62	7	176	112	KM 5	160
T 78227	20 x 30	6.5	18.0	38	66	7	167	111	KM 5	160
T 78228	22 x 35	6.5	18.0	45	96	8	202	127	KM 6	220
T 78229	24 x 35	6.5	18.0	45	105	9	185	127	KM 6	220
T 78230	25 x 35	6.5	18.0	45	110	9	178	127	KM 6	220
T 78231	28 x 40	7.0	19.5	52	150	10	176	123	KM 7	340
T 78232	30 x 40	7.0	19.5	52	160	11	164	123	KM 7	340
T 78233	32 x 45	8.0	21.5	58	210	12	167	120	KM 8	480
T 78234	35 x 45	8.0	21.5	58	230	13	153	120	KM 8	480
T 78235	36 x 45	8.0	21.5	58	240	13	149	120	KM 8	480
T 78236	38 x 52	10.0	24.5	65	290	14	126	93	KM 9	680
T 78237	40 x 52	10.0	24.5	65	310	15	120	93	KM 9	680
T 78238	42 x 57	10.0	25.5	70	370	17	131	96	KM10	870
T 78239	45 x 57	10.0	25.5	70	400	18	122	96	KM10	870
T 78240	48 x 62	10.0	25.5	75	500	21	135	105	KM11	970
T 78241	50 x 62	10.0	25.5	75	520	21	130	105	KM11	970
T 78242	55 x 68	12.0	27.5	80	610	22	103	84	KM12	1100
T 78243	56 x 68	12.0	27.5	80	620	22	101	82	KM12	1100
T 78244	60 x 73	12.0	28.5	85	800	27	113	93	KM13	1300
T 78245	63 x 79	14.0	30.5	92	980	31	107	86	KM14	1600
T 78246	65 x 79	14.0	30.5	92	1010	31	104	86	KM14	1600
T 78247	70 x 84	14.0	31.5	98	1240	35	110	92	KM15	2000

Rozmiary w mm.

Tuleje mocujące BK samocentrujące

Materiał

Stal C 43

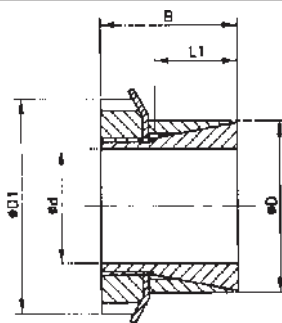

BK 26

Kod	d x D	L1	B	D1	Obrot. moment Nm	Osiowa siła kN	Nacisk na		Śruby mocujące	
							Wątek N/mm ²	Piasta N/mm ²	Śruby Typ	Dociąg. mom. Nm
T 78248	14 x 25	20	30	32	64	9	85	45	KM 4	95
T 78252	15 x 25	20	30	32	70	9	80	45	KM 4	95
T 78253	16 x 25	20	30	32	73	9	75	45	KM 4	95
T 78254	17 x 25	20	32	32	80	9	70	45	KM 4	95
T 78255	18 x 26	20	32	38	100	10	80	45	KM 5	160
T 78256	19 x 30	20	32	38	105	11	75	45	KM 5	160
T 78257	20 x 30	20	32	38	112	11	70	45	KM 5	160
T 78258	22 x 35	25	36	45	163	14	70	45	KM 6	220
T 78259	24 x 35	25	36	45	178	14	65	45	KM 6	220
T 78260	25 x 35	25	36	45	185	14	60	45	KM 6	220
T 78261	28 x 40	30	42	52	250	17	55	40	KM 7	340
T 78262	30 x 40	30	42	52	270	17	50	40	KM 7	340
T 78263	32 x 45	30	44	58	350	21	60	45	KM 8	480
T 78264	35 x 45	30	44	58	390	21	55	45	KM 8	480
T 78265	38 x 50	30	45	65	500	26	60	45	KM 9	680
T 78266	40 x 50	30	45	65	520	26	55	45	KM 9	680
T 78267	42 x 55	30	46	70	630	30	65	50	KM10	870
T 78268	45 x 55	30	46	70	680	30	60	50	KM10	870
T 78269	48 x 60	30	46	75	840	35	60	50	KM11	970
T 78270	50 x 60	30	46	75	880	35	60	50	KM11	970
T 78271	55 x 65	30	46	80	1030	37	60	50	KM12	1100
T 78272	60 x 70	30	52	85	1360	45	65	55	KM13	1300

Rozmiary w mm.

Tuleje mocujące BK

Material

Stal C 43

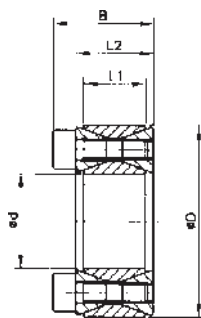

BK 40

Kod	d x D	L1	L2	B	Obrot. moment Nm	Osiowa siła kN	Nacisk na		Śruby mocujące	
							Wątek N/mm ²	Piasta N/mm ²	DIN 912 Typ	Dociąg. mom. Nm
T 33171	20 x 47	17	20	27.5	280	29	225	95	8 x M 6	15
T 33172	22 x 47	17	20	27.5	310	29	210	95	8 x M 6	15
T 33173	24 x 50	17	20	27.5	370	32	210	100	8 x M 6	15
T 33174	25 x 50	17	20	27.5	400	32	200	100	8 x M 6	15
T 33175	28 x 55	17	20	27.5	500	36	200	100	10 x M 6	15
T 33176	30 x 55	17	20	27.5	530	36	185	100	10 x M 6	15
T 33177	32 x 60	17	20	27.5	680	42	205	110	12 x M 6	15
T 33178	35 x 60	17	20	27.5	750	43	190	110	12 x M 6	15
T 33179	38 x 65	17	20	27.5	930	49	200	115	14 x M 6	15
T 33085	40 x 65	17	20	27.5	980	49	190	115	14 x M 6	15
T 33180	42 x 75	20	24	33.5	1580	75	235	130	12 x M 8	37
T 33181	45 x 75	20	24	33.5	1700	76	220	130	12 x M 8	37
T 33182	48 x 80	20	24	33.5	1790	74	210	120	12 x M 8	37
T 33183	50 x 80	20	24	33.5	1870	75	200	120	12 x M 8	37
T 33184	55 x 85	20	24	33.5	2390	88	210	135	14 x M 8	37
T 32907	60 x 90	20	24	33.5	2610	88	190	125	14 x M 8	37
T 33185	65 x 95	20	24	33.5	3210	98	200	135	16 x M 8	37
T 33186	70 x 110	24	28	39.5	4600	132	210	130	14 x M10	70
T 33187	75 x 115	24	28	39.5	4900	131	195	125	14 x M10	70
T 33188	80 x 120	24	28	39.5	5200	131	180	120	14 x M10	70
T 33189	85 x 125	24	28	39.5	6300	148	195	130	16 x M10	70
T 33190	90 x 130	24	28	39.5	6600	147	180	125	16 x M10	70
T 33191	95 x 135	24	28	39.5	7900	167	195	135	18 x M10	70
T 33192	100 x 145	26	33	47.0	9750	195	195	135	14 x M12	127
T 33193	110 x 155	26	33	47.0	10650	194	180	125	14 x M12	127
T 33194	120 x 165	26	33	47.0	13300	221	185	135	16 x M12	127
T 33195	130 x 180	34	38	52.0	17850	276	165	115	20 x M12	127
T 33196	140 x 190	34	38	52.0	21200	302	165	125	22 x M12	127
T 33197	150 x 200	34	38	52.0	24500	329	170	125	24 x M12	127
Na zapytanie	160 x 210	34	38	52.0	28400	355	170	130	26 x M12	127
	170 x 225	38	44	60.0	33600	396	165	120	28 x M14	195
	180 x 235	38	44	60.0	38700	431	170	130	24 x M14	195
	190 x 250	46	52	68.0	44700	502	155	120	28 x M14	195
	200 x 260	46	52	68.0	53500	538	155	120	30 x M14	195
	220 x 285	50	56	74.0	68500	630	155	120	26 x M16	300
	240 x 305	50	56	74.0	86000	717	165	130	30 x M16	300
	260 x 325	50	56	74.0	105000	810	165	135	34 x M16	300
	280 x 355	60	66	86.5	128500	920	150	120	32 x M18	410
	300 x 375	60	66	86.5	153600	1025	155	125	36 x M18	410
	320 x 405	72	78	100.5	210500	1325	155	125	36 x M20	590
	340 x 425	72	78	100.5	225000	1325	150	120	36 x M20	590
	360 x 455	84	90	116.0	294700	1635	150	120	36 x M22	790
	380 x 475	84	90	116.0	309100	1625	140	120	36 x M22	790
400 x 495	84	90	116.0	321900	1617	135	110	36 x M22	790	

Rozmiary w mm.

Tuleje mocujące BK

Material

Stal C 43

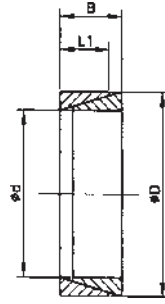

BK 50

Kod	d x D	L1	B	Nominalna siła ¹ N	Całkowita siła N	Obrot. mom. Nm	Osiowa siła kN	Odległość mocowania ²				Dystans		Nacisk na	
								1	2	3	4	Wew. d1	Zew. D1	Wałek N/mm ²	Piasta N/mm ²
Na zapytanie	6 x 9	3.7	4.5	-	3800	2	0.84	2.5	2.5	3.0	4.0	6.1	8.9	115	75
	7 x 10	3.7	4.5	-	3900	3	0.86	2.5	2.5	3.0	4.0	7.1	9.9	105	70
	8 x 11	3.7	4.5	-	5300	5	1.17	2.5	2.5	3.0	4.0	8.1	10.9	120	90
	9 x 12	3.7	4.5	7650	15600	8	1.76	2.5	2.5	3.0	4.0	9.1	11.9	140	105
	10 x 13	3.7	4.5	7000	15600	10	1.91	2.5	2.5	3.0	4.0	10.1	12.9	135	105
	12 x 15	3.7	4.5	7000	15600	11	1.91	2.5	2.5	3.0	4.0	12.1	14.9	115	90
	13 x 16	3.7	4.5	6500	15600	13	2.02	2.5	2.5	3.0	4.0	13.1	15.9	110	90
T 71111	14 x 18	5.3	6.3	11000	25400	22	3.18	3.5	3.5	4.5	5.5	14.1	17.9	115	90
T 73654	15 x 19	5.3	6.3	10800	25400	24	3.24	3.5	3.5	4.5	5.5	15.1	18.9	110	85
T 73649	16 x 20	5.3	6.3	10000	25400	27	3.42	3.5	3.5	4.5	5.5	16.1	19.9	105	85
T 78095	17 x 21	5.3	6.3	9600	25400	30	3.51	3.5	3.5	4.5	5.5	17.1	20.9	105	85
T 78096	18 x 22	5.3	6.3	9150	25400	32	3.61	3.5	3.5	4.5	5.5	18.1	21.9	100	80
T 78097	19 x 24	5.3	6.3	12500	36000	49	5.22	3.5	3.5	4.5	5.5	19.2	23.8	140	110
T 58008	20 x 25	5.3	6.3	12000	36000	53	5.33	3.5	3.5	4.5	5.5	20.2	24.8	135	105
T 78098	22 x 26	5.3	6.3	9000	36000	66	6.00	3.5	3.5	4.5	5.5	22.2	25.8	135	115
T 78099	24 x 28	5.3	6.3	8400	36000	73	6.13	3.5	3.5	4.5	5.5	24.2	27.8	130	110
T 69299	25 x 30	5.3	6.3	10000	36000	72	5.77	3.5	3.5	4.5	5.5	25.2	29.8	115	95
T 78100	28 x 32	5.3	6.3	7500	36000	88	6.33	3.5	3.5	4.5	5.5	28.2	31.8	115	100
T 73647	30 x 35	5.3	6.3	8600	36000	91	6.08	3.5	3.5	4.5	5.5	30.2	34.8	100	85
T 78101	32 x 36	5.3	6.3	7900	45000	131	8.24	3.5	3.5	4.5	5.5	32.2	35.8	130	115
T 73648	35 x 40	6.0	7.0	10000	54000	171	9.77	3.5	3.5	4.5	5.5	35.2	39.8	125	110
T 78102	36 x 42	6.0	7.0	11700	54000	169	9.39	3.5	3.5	4.5	5.5	36.2	41.8	115	100
T 73652	38 x 44	6.0	7.0	11000	54000	181	9.55	3.5	3.5	4.5	5.5	38.2	43.8	110	95
T 53441	40 x 45	6.6	8.0	13900	66000	231	11.57	3.5	4.5	5.5	6.5	40.2	44.8	115	105
T 77377	42 x 48	6.6	8.0	15550	66000	235	11.22	3.5	4.5	5.5	6.5	42.2	47.8	110	95
T 78103	45 x 52	8.6	10.0	28300	99000	353	15.71	3.5	4.5	5.5	6.5	45.2	51.8	105	95
T 78104	48 x 55	8.6	10.0	24700	132000	572	23.84	3.5	4.5	5.5	6.5	48.2	54.8	155	135
T 73651	50 x 57	8.6	10.0	23600	132000	602	24.08	3.5	4.5	5.5	6.5	50.2	56.8	150	130
T 78105	55 x 62	8.6	10.0	21700	132000	670	24.35	3.5	4.5	5.5	6.5	55.2	61.8	140	125
T 78106	56 x 64	10.4	12.0	29500	157200	790	28.20	3.5	4.5	5.5	7.0	56.2	63.8	130	115
T 78107	60 x 68	10.4	12.0	27500	157200	860	28.60	3.5	4.5	5.5	7.0	60.2	67.8	125	110
T 78108	63 x 71	10.4	12.0	26500	157200	910	28.80	3.5	4.5	5.5	7.0	63.2	70.8	120	105
T 78109	65 x 73	10.4	12.0	25500	157200	950	29.20	3.5	4.5	5.5	7.0	65.2	72.8	115	100
T 78110	70 x 79	12.2	14.0	31000	209600	1380	39.40	3.5	5.0	6.5	7.5	70.3	78.7	125	110

Rozmiary w mm.

¹ Nominalna siła potrzebna do pomiaru luzu

² Potrzebna odległość mocowania kołnierzy.

Tuleje mocujące BK

Materiał

Stal C 43

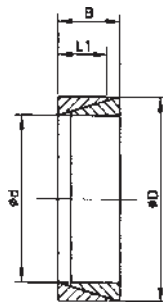

BK 50

Kod	d x D	L1	B	Nominalna siła ¹ N	Całkowita siła N	Obrot. mom. Nm	Osiowa siła kN	Odległość mocowania ²				Dystans		Nacisk na	
								1	2	3	4	Wew. d1	Zew. D1	Wałek N/mm ²	Piasta N/mm ²
T 78111	71 x 80	12.2	14.0	31000	209600	1400	39.40	3.5	5.0	6.5	7.5	71.3	79.7	120	110
T 78112	75 x 84	12.2	14.0	34700	209600	1450	38.60	3.5	5.0	6.5	7.5	75.3	83.7	115	100
T 73650	80 x 91	15.0	17.0	48000	290000	2200	55.00	4.0	6.0	6.5	8.0	80.3	90.7	125	105
T 78113	85 x 96	15.0	17.0	45500	305000	2400	56.40	4.0	6.0	6.5	8.0	85.3	95.7	120	105
T 78114	90 x101	15.0	17.0	43600	320000	2730	60.50	4.0	6.0	6.5	8.0	90.3	100.7	120	105
T 78115	95 x106	15.0	17.0	41300	330000	3050	64.20	4.0	6.0	6.5	8.0	95.3	105.7	120	110
T 78116	100 x114	18.7	21.0	61000	445000	4200	84.00	5.0	6.0	7.0	9.0	100.3	113.7	120	105
Na zapytanie	110 x124	18.7	21.0	66000	485000	5150	93.60	5.0	6.0	7.0	9.0	110.3	123.7	120	105
	120 x134	18.7	21.0	60300	510000	6050	100.80	5.0	6.0	7.0	9.0	120.3	133.7	120	105
	130 x148	25.3	28.0	96300	765000	9600	147.60	5.0	7.0	9.0	11.0	130.4	147.6	120	105
	140 x158	25.3	28.0	89000	800500	11000	158.50	6.0	7.0	9.0	11.0	140.4	157.6	120	105
	150 x168	25.3	28.0	85000	860000	12900	172.00	6.0	7.0	9.0	11.0	150.4	167.6	120	105
	160 x178	25.3	28.0	78600	900000	14600	182.50	6.0	7.0	9.0	11.0	160.4	177.6	120	110
	170 x191	30.0	33.0	117400	1160000	19500	229.00	7.0	9.0	10.0	12.0	170.5	190.5	120	105
180 x201	30.0	33.0	111300	1200000	21300	236.00	7.0	9.0	10.0	12.0	180.5	200.5	120	105	

Rozmiary w mm.

¹ Nominalna siła potrzebna do pomiaru luzu.

² Potrzebna odległość mocowania kołnierzy.

Tuleje mocujące BK samocentrujące

Material

Stal C 43

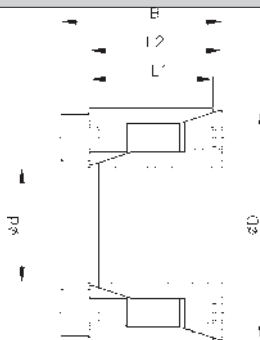

BK 61

Kod	d x D	L1	L2	B	Obrot. moment Nm	Osiowa siła kN	Nacisk na		Śruby mocujące	
							Wątek N/mm ²	Piasta N/mm ²	DIN 912 Typ	Dociąg. mom. Nm
F07100	10 x 20	12,5	13	15,5	20	4	124	62	4 x M 2,5	1,2
F07101	11 x 22	12,5	13	15,5	22	4	113	56	4 x M 2,5	1,2
F07102	12 x 22	12,5	13	15,5	24	4	104	56	4 x M 2,5	1,2
F07103	14 x 26	16,5	17	20	42	6	99	53	4 x M 3	2,1
F07104	15 x 28	16,5	17	20	44	6	93	50	4 x M 3	2,1
F07105	16 x 32	16,5	17	21	83	10,4	152	76	4 x M 4	4,9
F07106	17 x 35	20,5	21	25	88	10,4	116	56	4 x M 4	4,9
F07107	18 x 35	20,5	21	25	93	10,4	109	56	4 x M 4	4,9
F07108	19 x 35	20,5	21	25	99	10,4	104	56	4 x M 4	4,9
F07109	20 x 38	20,5	21	26	170	17	161	85	4 x M 5	10
F07110	22 x 40	20,5	21	26	187	17	146	80	4 x M 5	10
F07111	24 x 47	25	26	32	287	24	153	78	4 x M 6	17
F07112	25 x 47	25	26	32	299	24	147	78	4 x M 6	17
F07113	28 x 50	25	26	32	503	36	196	110	6 x M 6	17
F07114	30 x 55	25	26	32	539	36	183	100	6 x M 6	17
F07115	32 x 55	25	26	32	575	36	172	100	6 x M 6	17
F07116	35 x 60	30	31	37	838	48	176	102	8 x M 6	17
F07117	38 x 65	30	31	37	910	48	162	95	8 x M 6	17
F07118	40 x 65	30	31	37	958	48	154	95	8 x M 6	17
F07119	42 x 75	35	36	44	1394	66,3	175	98	6 x M 8	41
F07120	45 x 75	35	36	44	1493	66,3	163	98	6 x M 8	41
F07121	48 x 80	35	36	44	2124	88,5	204	122	8 x M 8	41
F07122	50 x 80	35	36	44	2212	88,5	196	122	8 x M 8	41

Rozmiary w mm.

Tuleje mocujące BK samocentrujące

Material

Stal C 43

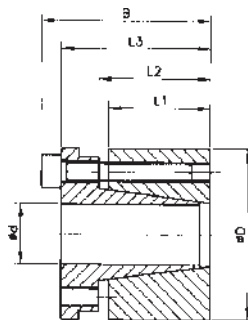

BK 70

Kod	d x D	L1	L2	L3	B	Obrot. moment Nm	Osiowa siła kN	Nacisk na		Śruby mocujące	
								Wątek N/mm ²	Piasta N/mm ²	DIN 912 Typ	Dociąg. mom. Nm
T 62573	20 x 47	26	29.0	42.0	48.0	540	54	250	105	6 x M 6	17
T 62574	22 x 47	26	29.0	42.0	48.0	600	54	230	105	6 x M 6	17
T 78130	24 x 50	26	29.0	42.0	48.0	650	54	210	100	6 x M 6	17
T 62572	25 x 50	26	29.0	42.0	48.0	680	54	200	100	6 x M 6	17
T 78131	28 x 55	26	29.0	42.0	48.0	760	54	180	95	6 x M 6	17
T 62571	30 x 55	26	29.0	42.0	48.0	820	54	170	95	6 x M 6	17
T 78132	32 x 60	26	29.0	42.0	48.0	1310	82	235	125	9 x M 6	17
T 78133	35 x 60	26	29.0	42.0	48.0	1440	82	215	125	9 x M 6	17
T 78134	38 x 65	26	29.0	42.0	48.0	1560	82	200	115	9 x M 6	17
T 62570	40 x 65	26	29.0	42.0	48.0	1640	82	190	115	9 x M 6	17
T 78135	42 x 75	30	34.4	51.0	59.0	2130	101	215	120	6 x M 8	41
T 78136	45 x 75	30	34.4	51.0	59.0	2280	101	200	120	6 x M 8	41
T 78137	48 x 80	30	34.4	51.0	59.0	2430	101	190	115	6 x M 8	41
T 61878	50 x 80	30	34.4	51.0	59.0	2530	101	180	115	6 x M 8	41
T 78138	55 x 85	30	34.4	51.0	59.0	4180	152	245	160	9 x M 8	41
T 78139	60 x 90	30	34.4	51.0	59.0	4560	152	225	150	9 x M 8	41
T 78140	65 x 95	30	34.4	51.0	59.0	4940	152	210	145	9 x M 8	41
T 62569	70 x 110	40	45.0	56.0	66.0	6500	186	175	110	7 x M10	83
T 78141	75 x 115	40	45.0	56.0	66.0	7000	186	165	110	7 x M10	83
T 78142	80 x 120	40	45.0	56.0	66.0	7400	186	155	100	7 x M10	83
T 78143	85 x 125	40	45.0	56.0	66.0	9000	213	170	115	8 x M10	83
T 46339	90 x 130	40	45.0	56.0	66.0	9600	213	160	110	8 x M10	83
T 78144	95 x 135	40	45.0	56.0	66.0	12600	267	185	130	10 x M10	83
T 78145	100 x 145	46	52.0	65.0	77.0	13300	270	160	105	7 x M12	145
Na zapytanie	110 x 155	46	52.0	65.0	77.0	14700	270	140	100	7 x M12	145
	120 x 165	46	52.0	65.0	77.0	18400	309	150	110	8 x M12	145
	130 x 180	46	52.0	65.0	77.0	25100	388	175	125	10 x M12	145
	140 x 190	51	58.5	73.5	87.5	40150	586	220	160	11 x M14	230
	150 x 200	51	58.5	73.5	87.5	47000	639	225	165	12 x M14	230
	160 x 210	51	58.5	73.5	87.5	54300	692	225	170	13 x M14	230
	170 x 225	51	58.5	73.5	87.5	63000	746	230	175	14 x M14	230
180 x 235	51	58.5	73.5	87.5	66000	746	215	170	14 x M14	230	

Rozmiary w mm.

Tuleje mocujące BK samocentrujące

Material

Stal C 43

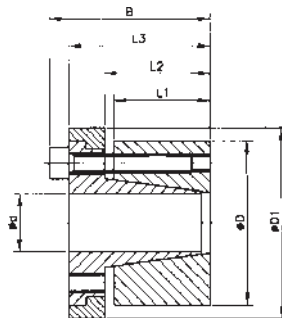

BK 71

Kod	d x D	L1	L2	L3	B	D1	Obrot. moment Nm	Osiowa siła kN	Nacisk na		Śruby mocujące	
									Wątek N/mm ²	Piasta N/mm ²	DIN 912 Typ	Dociąg. mom. Nm
T 78164	20 x 47	26	29.0	42.0	48.0	53	330	33.6	155	65	6 x M 6	17
T 78165	22 x 47	26	29.0	42.0	48.0	53	370	33.6	145	65	6 x M 6	17
T 78166	24 x 50	26	29.0	42.0	48.0	56	400	33.6	140	60	6 x M 6	17
T 78167	25 x 50	26	29.0	42.0	48.0	56	420	33.6	125	60	6 x M 6	17
T 78168	28 x 55	26	29.0	42.0	48.0	61	470	33.6	110	60	6 x M 6	17
T 78169	30 x 55	26	29.0	42.0	48.0	61	510	33.6	105	60	6 x M 6	17
T 78170	32 x 60	26	29.0	42.0	48.0	66	810	51.0	145	80	9 x M 6	17
T 78171	35 x 60	26	29.0	42.0	48.0	66	890	51.0	135	80	9 x M 6	17
T 78172	38 x 65	26	29.0	42.0	48.0	71	970	51.0	125	70	9 x M 6	17
T 78173	40 x 65	26	29.0	42.0	48.0	71	1020	51.0	120	70	9 x M 6	17
T 78174	42 x 75	30	34.4	51.0	59.0	81	1320	62.8	135	75	6 x M 8	41
T 78175	45 x 75	30	34.4	51.0	59.0	81	1410	62.8	125	75	6 x M 8	41
T 78176	48 x 80	30	34.4	51.0	59.0	86	1510	62.8	120	70	6 x M 8	41
T 78177	50 x 80	30	34.4	51.0	59.0	86	1570	62.8	110	70	6 x M 8	41
T 78178	55 x 85	30	34.4	51.0	59.0	91	2600	94.6	150	100	9 x M 8	41
T 78179	60 x 90	30	34.4	51.0	59.0	96	2830	94.6	140	95	9 x M 8	41
T 78180	65 x 95	30	34.4	51.0	59.0	102	3070	94.6	130	90	9 x M 8	41
T 78181	70 x 110	40	45.0	56.0	66.0	117	4000	116.0	110	70	7 x M10	83
T 78182	75 x 115	40	45.0	56.0	66.0	122	4300	116.0	100	65	7 x M10	83
T 78183	80 x 120	40	45.0	56.0	66.0	127	4600	116.0	100	65	7 x M10	83
T 78184	85 x 125	40	45.0	56.0	66.0	132	5600	133.0	105	70	8 x M10	83
T 78185	90 x 130	40	45.0	56.0	66.0	137	6000	133.0	100	70	8 x M10	83
T 78186	95 x 135	40	45.0	56.0	66.0	142	7900	167.0	115	80	10 x M10	83
T 78187	100 x 145	46	52.0	65.0	77.0	153	8470	169.0	100	65	7 x M12	145
Na zapytanie	110 x 155	46	52.0	65.0	77.0	163	9200	169.0	90	65	7 x M12	145
	120 x 165	46	52.0	65.0	77.0	173	11600	193.0	90	70	8 x M12	145
	130 x 180	46	52.0	65.0	77.0	188	15700	242.0	110	80	10 x M12	145
	140 x 190	51	58.5	73.5	87.5	199	25300	366.0	135	100	11 x M14	230
	150 x 200	51	58.5	73.5	87.5	209	29500	399.0	140	105	12 x M14	230
	160 x 210	51	58.5	73.5	87.5	219	31900	432.0	140	110	13 x M14	230
	170 x 225	51	58.5	73.5	87.5	234	39500	466.0	145	110	14 x M14	230
180 x 235	51	58.5	73.5	87.5	244	41500	466.0	135	105	14 x M14	230	

Rozmiary w mm.

Tuleje mocujące BK samocentrujące

Material

Stal C 43

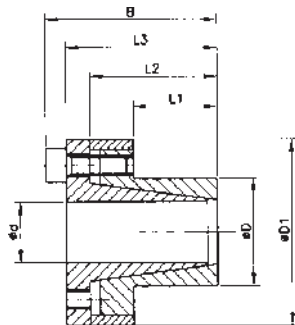

BK 80

Kod	d x D	L1	L2	L3	B	D1	Obrot. moment Nm	Osiowa siła kN	Nacisk na		Śruby mocujące	
									Wątek N/mm ²	Piasta N/mm ²	DIN 912 Typ	Dociąg. mom. Nm
Na zapytanie	6 x 14	10	18.5	21	24	25	12	4	185	80	3 x M 3	2
	7 x 15	12	22.0	25	29	27	25	7	235	110	3 x M 4	5
	8 x 15	12	22.0	25	29	27	29	7	205	110	3 x M 4	5
	9 x 16	14	23.0	26	30	28	44	10	205	115	4 x M 4	5
	10 x 16	14	23.0	26	30	28	49	10	185	115	4 x M 4	5
	11 x 18	14	23.0	26	30	32	53	10	170	105	4 x M 4	5
	12 x 18	14	23.0	26	30	32	58	10	160	105	4 x M 4	5
	13 x 23	14	23.0	26	30	38	63	10	140	80	4 x M 4	5
	14 x 23	14	23.0	26	30	38	68	10	130	80	4 x M 4	5
15 x 24	16	29.0	36	42	45	127	17	185	115	3 x M 6	17	
T 67998	16 x 24	16	29.0	36	42	45	136	17	175	115	3 x M 6	17
T 78147	17 x 26	18	31.0	38	44	47	180	22	190	125	4 x M 6	17
T 78148	18 x 26	18	31.0	38	44	47	200	22	180	125	4 x M 6	17
T 73656	19 x 27	18	31.0	38	44	49	210	22	170	120	4 x M 6	17
T 73658	20 x 28	18	31.0	38	44	50	220	22	160	115	4 x M 6	17
T 78149	22 x 32	25	38.0	45	51	54	250	22	115	80	4 x M 6	17
T 73661	24 x 34	25	38.0	45	51	56	270	22	105	75	4 x M 6	17
T 58956	25 x 34	25	38.0	45	51	56	280	22	100	75	4 x M 6	17
T 78150	28 x 39	25	38.0	45	51	61	465	33	135	97	6 x M 6	17
T 58294	30 x 41	25	38.0	45	51	62	510	33	127	90	6 x M 6	17
T 73655	32 x 43	25	38.0	45	51	65	540	33	120	90	6 x M 6	17
T 78151	35 x 47	32	45.0	52	58	69	790	45	105	80	8 x M 6	17
T 61128	38 x 50	32	45.0	52	58	72	860	45	100	75	8 x M 6	17
T 73660	40 x 53	32	45.0	52	58	75	900	45	95	70	8 x M 6	17
T 78152	42 x 55	32	45.0	52	58	78	950	45	90	70	8 x M 6	17
T 78153	45 x 59	45	62.0	70	78	86	1890	84	110	85	8 x M 8	41
T 73657	48 x 62	45	62.0	70	78	87	2010	84	105	80	8 x M 8	41
T 78154	50 x 65	45	62.0	70	78	92	2100	84	100	75	8 x M 8	41
T 78155	55 x 71	55	72.0	80	88	98	2600	94	85	65	9 x M 8	41
T 73663	60 x 77	55	72.0	80	88	104	2840	94	75	60	9 x M 8	41
T 61368	65 x 84	55	72.0	80	88	111	3070	94	70	55	9 x M 8	41
T 78156	70 x 90	65	86.0	96	106	119	5250	150	90	70	9 x M10	83
T 61369	75 x 95	65	86.0	96	106	126	5600	150	80	65	9 x M10	83
T 78157	80 x 100	65	86.0	96	106	131	8020	200	100	80	12 x M10	83
Na zapytanie	85 x 106	65	86.0	96	106	137	8500	200	95	75	12 x M10	83
	90 x 112	65	86.0	96	106	144	9000	200	90	75	12 x M10	83
	95 x 120	65	86.0	96	106	149	11000	230	100	80	14 x M10	83
	100 x 125	65	86.0	96	106	154	15000	300	120	95	18 x M10	83
	110 x 140	90	114.0	128	140	180	16000	290	80	65	12 x M12	145
	120 x 155	90	114.0	128	140	198	17500	290	70	55	12 x M12	145
	130 x 165	90	114.0	128	140	208	25000	384	90	70	16 x M12	145

Rozmiary w mm.